



**User manual**  
**Solar Grid-tied Inverter**  
Product Model: SOFAR 255KTL-HV



---

---

## Contents

Preface.....	ii
1. Basic Safety Information.....	- 1 -
1.1. Requirement for Installation and Maintenance.....	- 1 -
1.2. Symbols and signs.....	- 4 -
2. Product Characteristics.....	- 6 -
2.1. Intended Use.....	- 6 -
2.2. Function Description.....	- 8 -
2.3. Electrical block diagram.....	- 10 -
2.4. Efficiency and derating curve.....	- 12 -
3. Inverter Storage.....	- 13 -
4. Installation.....	- 14 -
4.1. Installation Process.....	- 14 -
4.2. Checking Before Installation.....	- 14 -
4.3. Tools.....	- 16 -
4.4. Determining the Installation Position.....	- 18 -
4.5. Moving of inverter.....	- 21 -
4.6. Installation.....	- 23 -
5. Electrical Connection.....	- 27 -
5.1. Electrical Connection.....	- 28 -
5.2. Terminal Connector.....	- 28 -
5.3. Grounding Connection (PE).....	- 29 -
5.4. Connect grid side of inverter(AC-Output).....	- 30 -
5.4.2 Wiring Terminal and Precautions .....	- 31 -
5.5. Connect PV side of inverter (DC-Input) .....	- 35 -
5.6. Communication Connection.....	- 38 -
6. Commissioning of inverter.....	- 40 -
6.1. Cable Connection Inspection.....	- 40 -
6.2. Start Inverter.....	- 40 -
7. Operation interface.....	- 41 -
7.1. Operation and Display Panel.....	- 41 -
7.2. Standard Interface.....	- 42 -
7.3. Main Interface.....	- 45 -
7.4. Updating Inverter Software.....	- 47 -
8. Trouble shooting and maintenance.....	- 49 -
8.1. Troubleshooting.....	- 49 -
8.2. Maintenance.....	- 58 -
9. Technical Data.....	- 59 -
9.1. Input parameters (DC).....	- 59 -
9.2. Output Parameter (AC).....	- 60 -
9.3. Performance Parameter.....	- 61 -
9.4. General Data.....	- 62 -
10. Quality Assurance.....	- 63 -

# Preface

## Notice

The products, services or features you purchased shall be subject to the company's commercial contracts and terms. All or part of the products and services described in this document may not within the scope of your purchase. Unless additional terms and conditions in your contract, the company does not make any statement or guarantee on the contents of this document.

## Save this Instruction

This manual must be considered as an integral part of the equipment. Customer can print the electronic version to hard copy and keeping properly for future reference. Anyone who operates the device at any time must operate in accordance with the requirements of this manual.

## Copyright Declaration

The copyright of this manual belongs to Shenzhen SOFARSOLAR Co., Ltd. Any corporation or individual should not plagiarize, partially cope or fully copy (including software, etc.), not allow to duplication and publishment in any form and any way. All rights reserved, SOFARSOLAR reserves the right of final interpretation. This manual subject to modify according to user's or customer's feedback. Please check our website at <http://www.sofarsolar.com> for lasted version.

The current Version updated at 20210319.

## Shenzhen SOFARSOLAR Co., Ltd

Location: 401,building 4, Antongda Industrial Park, District 68,XingDong Community, XinAn Street, BaoAn District, Shenzhen, China.

Postcode: 518000

Company Website: [www.sofarsolar.com](http://www.sofarsolar.com)

Email: [service@sofarsolar.com](mailto:service@sofarsolar.com)

- **Outline**

This manual is an integral part of SOFAR 250/255KTL-HV. It describes the assembly, installation, commissioning ,maintenance and failure of the product. Please read it carefully before operating.

- **Scope of Validity**

This manual contains important instructions for:





**SOFAR 250KTL-HV,SOAFR 255KTL-HV**

- **Target Group**

This manual is for qualified electricians. The tasks described in this manual only can be performed by qualified electricians.

- **Symbols Used**

The following types of safety instruction and general information appear in this document as described below:

 <b>Danger</b>	<p>“Danger”indicates a hazardous situation which, if not avoided, will result in death or serious injury.</p>
 <b>Warning</b>	<p>“Warning”indicates a hazardous situation which, if not avoided, could result in death or serious injury.</p>
 <b>Caution</b>	<p>“Caution”indicates a hazardous situation which, if not avoided, could result in minor or moderate injury.</p>
 <b>Attention</b>	<p>“Attention”indicates there are potential risks, if fail to prevent, may lead to equipment cannot normally or property damage.</p>
 <b>Note</b>	<p>“Note”provides additional information and tips that are valuable for the optimal operation of the product.</p>

# 1. Basic Safety Information

## Outlines of this Chapter

Please read the instruction carefully. Faulty operation may cause serious injury or death .

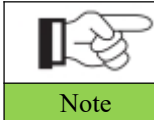

If you have any question or problem when you read the following information, please contact Shenzhen SOFARSOLAR CO., Ltd.

### Safety Instruction

Introduce the safety instruction during installation and operation of SOFAR 250/255KTL-HV.

### Symbols Instruction

This section gives an explanation of all the symbols shown on the inverter and on the type label.

## 1.1. Requirement for Installation and Maintenance

Installation of SOFAR 250/255KTL-HV on-grid inverter must conform with laws, regulations, codes and standards applicable in the jurisdiction.

Before installing and adjusting the produce, please read all of instructions, cautions and warnings in this manual

Before connecting the product to the electrical utility grid, contact the local utility company for allowance. Also, this connection must be made only by qualified electrician.

If the failure persists, please contact the nearest authorized maintenance center. If you don't know which service center is closest to you, please contact your local distributor. Don't repair the product by yourself, which may lead serious injury or damage.

### Qualified Person

When inverter is working, it contains lethal voltages and went hot in some area. Improper installation or misoperation could cause serial damage and injury. To

reduce the risk of personal injury and to ensure the safe installation and operation of the product, only a qualified electrician is allowed to execute transportation, installation, commissioning and maintenance. Shenzhen SOFARSOLAR Co, Ltd does not take any responsibility for the property destruction and personal injury because of any incorrect use.

### **Label and Symbols**

SOFAR 250/255KTL-HV has type label attach the side of product which contact important information and technical data, the type label must permanent attached to the product.

SOFAR 250/255KTL-HV has warning symbol attache the product which contact information of safety operation. The warning symbol must permanent attached to the product.

### **Installation location requirement**

Please install the inverter according to the following section. Place inverter in an appropriate bearing capacity objects (such as solid brick wall, or strength equivalent mounting surface, etc.) and make sure inverter vertical placed. A proper installation location must have enough space for fire engine access in order for maintenance if faulty occur. Ensure the inverter is installed in a wall ventilated environment and have enough air cooling cycle. Air humidity should less than 90%.

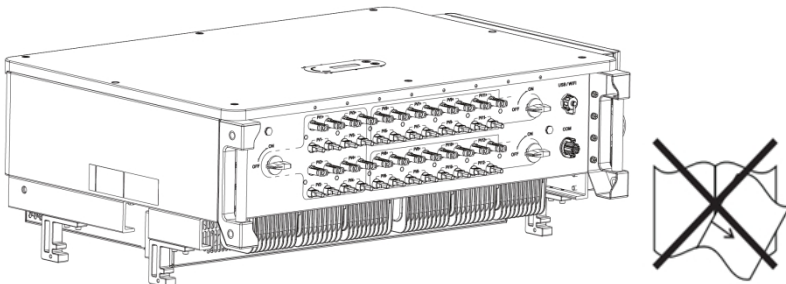

### **Transportation Requirement**



Inverter is in the good electrical and physical condition when it ship out from factory. During transport, inverter must be placed in its original package or other

proper package. Transportation company should responsible for any damage during transport period.



If you find any packing problems that may cause the damage of inverter or any visible damage, please notice the responsible transportation company immediately. You can ask your installer or SOFARSOLAR for help if necessary.

### Electrical Connection

Please comply with all the current electrical regulations about accident prevention in dealing with the current inverter.

 <b>Danger</b>	<p>Before the electrical connection, use opaque material to cover the PV modules or disconnect PV string DC switch. PV arrays will produce dangerous voltage if it is exposure under sun</p>
 <b>Warning</b>	<p>All operation must accomplish by certified electrical engineer</p> <ul style="list-style-type: none"> <li>● Must be trained;</li> <li>● Completely read the manual operation and understand all information</li> </ul>
 <b>Attention</b>	<p>Must get permission by local utility company before connecting to grid and the connection must be done by certified electrical engineers</p>

### Operation

 <b>Danger</b>	<p>Touching the utility grid or the terminal conductors can lead to lethal electric shock or fire!</p> <p>Do not touch non-insulated cable ends, DC conductors and any live components of the inverter.</p> <p>Attention to any electrical relevant instruction and document.</p>
 <b>Attention</b>	<p>Enclosure or internal components may get hot during operation. Do not touch hot surface or wear insulated gloves.</p> <p>Keep it away from kids !</p>

### Maintenance and repair

 <b>Danger</b>	<p>Before any repair work, turn OFF the AC circuit breaker between the inverter and electrical grid first, then turn OFF the DC switch. After turning OFF the AC circuit breaker and DC switch wait for at least 5 minutes before carry any maintenance or repair work.</p>
------------------------------------------------------------------------------------------------------	-----------------------------------------------------------------------------------------------------------------------------------------------------------------------------------------------------------------------------------------------------------------------------

	<p>Inverter should not work again until removing all faults. If any repair work is required, please contact local authorized service centre.</p>
<p>Attention</p>	<p>Should not open the inverter cover without authorized permit, SOFARSOLAR does not take any responsibility for that.</p>





**EMC/Noise Level**

Electromagnetic compatibility (EMC) refers to that on electrical equipment functions in a given electromagnetic environment without any trouble or error, and impose no unacceptable effect upon the environment. Therefore, EMC represents the quality characters of an electrical equipment.

- The inherent noise-immune character: immunity to internal electrical noise
- External noise immunity: immunity to electromagnetic noise of external system
- Noise emission level: influence of electromagnetic emission upon environment

	<p>Electromagnetic radiation from inverter may be harmful to health! Please do not continue to stay away from the inverter in less than 20cm when inverter is working.</p>
<p>Danger</p>	









**1.2. Symbols and signs**

	<p>High voltage of inverter may be harmful to health! Only certified engineer can operate the product; Juveniles, Disable, should not use this product;</p>
<p>Danger</p>	
	<p>Caution of burn injuries due to hot enclosure! Only touch the screen and pressing key of the inverter while it is working.</p>
<p>Caution</p>	
	<p>PV array should be grounded in accordance to the requirements of the local electrical grid company.</p>
<p>Attention</p>	
	<p>Ensure the maximum DC voltage input is less than the maximum inverter DC voltage (including in low temperature condition). Any damage cause by overvoltage, SOFARSOLAR will not take the responsibility including warranty.</p>
<p>Warning</p>	



### Signs on the Product and on the Type Label

SOFAR 250/255KTL-HV has some safety symbols on the inverter. Please read and fully understand the content of the symbols before installation.

Symbols	Name	Explanation
	This is a residual voltage in the inverter!	After disconnect with the DC side, there is a residual voltage in the inverter, operator should wait for 5 minutes to ensure the capacitor is completely discharged.
	Caution of high voltage and electric shock	The products operates at high voltages. Prior to performing any work on the product, disconnect the product from voltage sources. All work on the product must be carried out by qualified persons only.
	Caution of hot surface	The product can get hot during operation. Avoid contact during operation. Prior to performing any work on the product, allow the product to cool down sufficiently
	Comply with the Conformance Euroenne (CE) Certification	The product comply with the CE Certification
	Grounding Terminal	This symbol indicates the position for the connections of an additional equipment grounding conductor
	Observe the documentation	Read all documentation supplied with the product before install
	Positive pole and negative pole	Positive pole and negative pole of the input voltage (DC)
	Temperature	Indicated the temperature allowance range
	RCM logo	RCM (Regulatory Compliance Mark) The product complies with the requirements of the applicable Australian standards.

# 2. Product Characteristics

## Outlines of this Chapter

### Product Dimensions

Introduce the field of use and the dimensions of the product.

### Function Description

Introduce working principle and internal components.

### Efficiency Curves

Introduce the efficiency curves of the product.

## 2.1. Intended Use

SOFAR 250/255KTL-HV is a transformerless on grid PV inverter, that converts the direct current of the PV array to the grid-compliant, three-phase current and feeds into the utility grid.

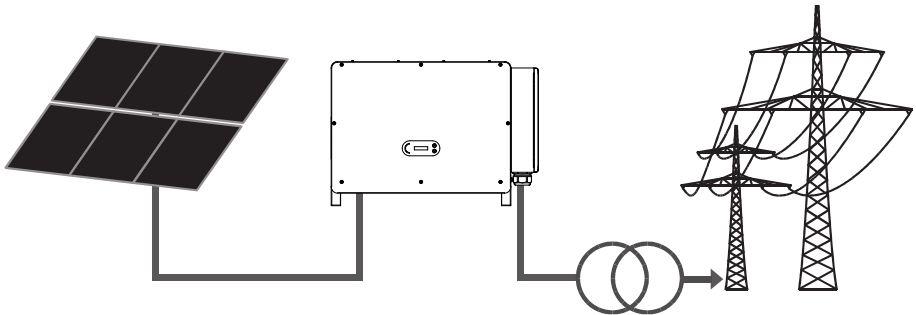

Figures 2-1 PV Grid-Tied System

SOFAR 250/255KTL-HV may only be operated with PV arrays (photovoltaic module and cabling) for on grid condition. Do not use this product for any other or additional purposes. Any damage or property loss due to any use of the product other than described in this section, SOFARSOLAR will not take the responsibility. DC input of the product must be PV module, other source such like DC sources, batteries will against the warranty condition and SOFARSOLAR will not take the responsibility.

## Product Dimensions

The choice of optional parts of inverter should be made by a qualified technician who knows the installation conditions clearly.

### Dimensions Description

- SOFAR 250/255KTL-HV

L×W×H=1100.5\*713.5\*368mm

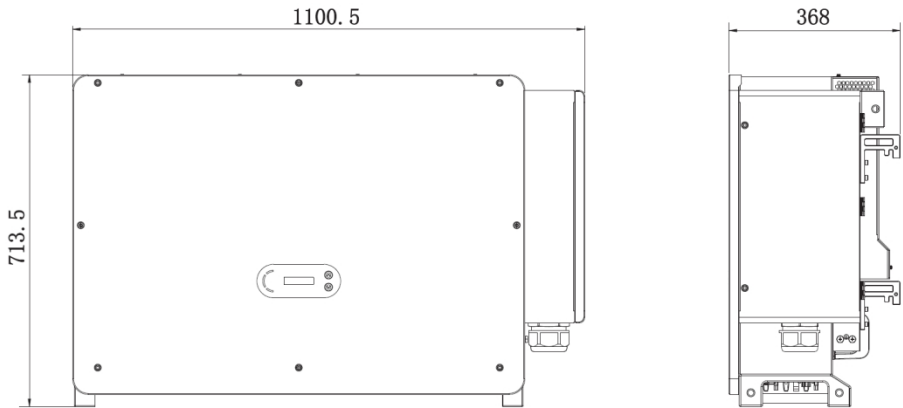
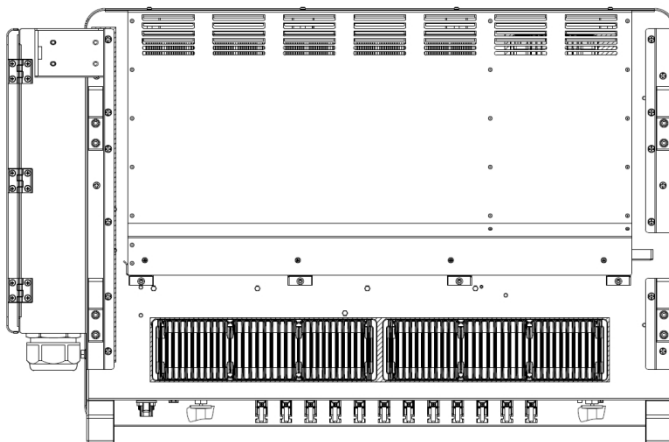

Figure 2-2 Product front view and left view dimensions



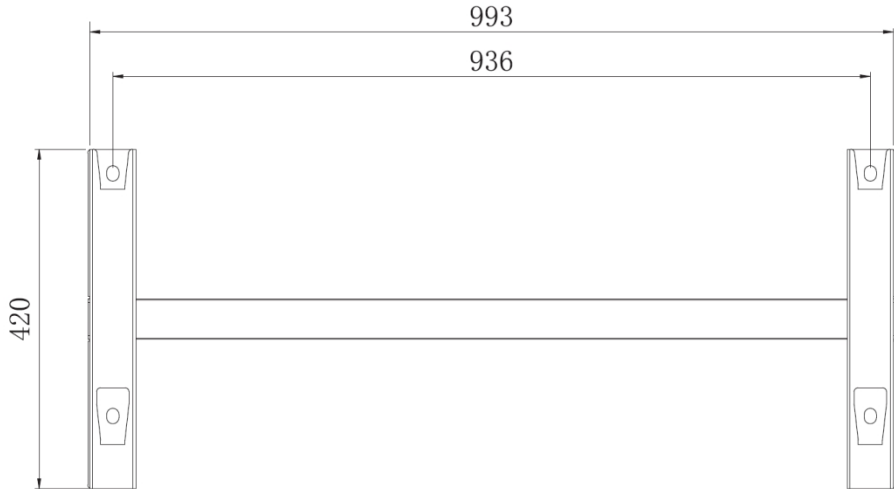

Figure 2-3 Product back view and bracket dimensions

◆ **Labels on the equipment**

Note: label must NOT be hidden with objects and extraneous parts (rags, boxes, equipment, etc.); they must be cleaned regularly and kept visible at all times.

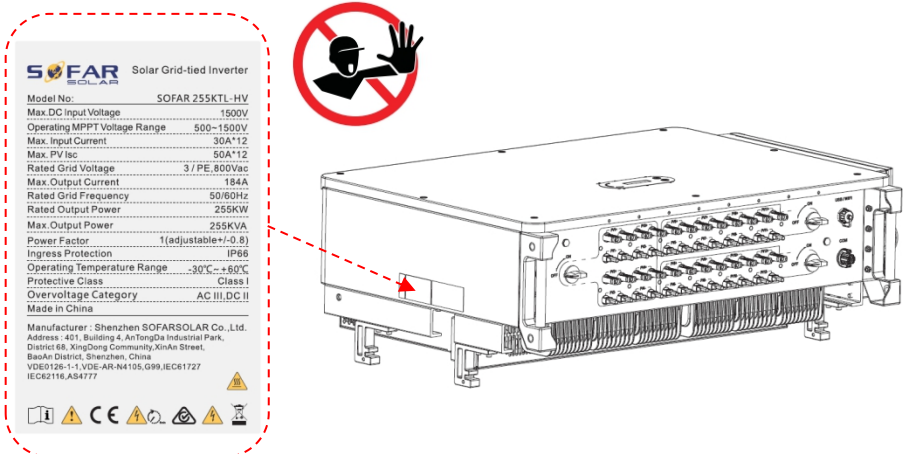

Figure 2-4 Product label

## 2.2. Function Description

DC power generated by PV arrays is filtered through Input Board then enter Power

Board. Input Board also offer functions such as insulation impedance detection and input DC voltage/ current detection. DC power is converted to AC power by Power Board. AC power is filtered through Output Board then AC power is fed into the grid. Output Board also offer functions such as grid voltage/ output current detection, GFCI and output isolation relay. Control Board provides the auxiliary power, controls the operation state of inverter and shows the operation status by Display Board. Display Board displays fault code when inverter is abnormal operation conditions. At the same time, Control Board can trigger the replay to protect the internal components.

## Function Module

### **A. Energy management unit**

Remote control to start/ shunt down inverter through an external control.

### **B. Feeding reactive power into the grid**

The inverter is able to produce reactive power thus to feed it into the grid through the setting of the phase shift factor. Feed-in management can be controlled directly by the grid company through a RS485 interface.

### **C. Limited the active power fed into grid**

If enable the limited of active power function, inverter can limit the amount of active power fed into the grid to the desired value (expressed as percentage).

### **D. Self-power reduction when grid is over frequency**

If grid frequency is higher than the limited value, inverter will reduce the output power to ensure the grid stability.

### **E. Data transmission**

Inverter or a group of inverters can be monitored remotely through an advanced communication system based on RS485 interface or via Wi-Fi.'

### **F. Software update**

USB interface for uploading the firmware, remotely uploading is available.

### 2.3. Electrical block diagram

SOFAR 250/255KTL-HV has 16-24 DC input strings. 8-12 MPPT trackers that converts the direct current of PV array to grid-compliant, three phase current and feeds in into the utility grid. Both DC and AC side has Surge Protection Device (SPD).

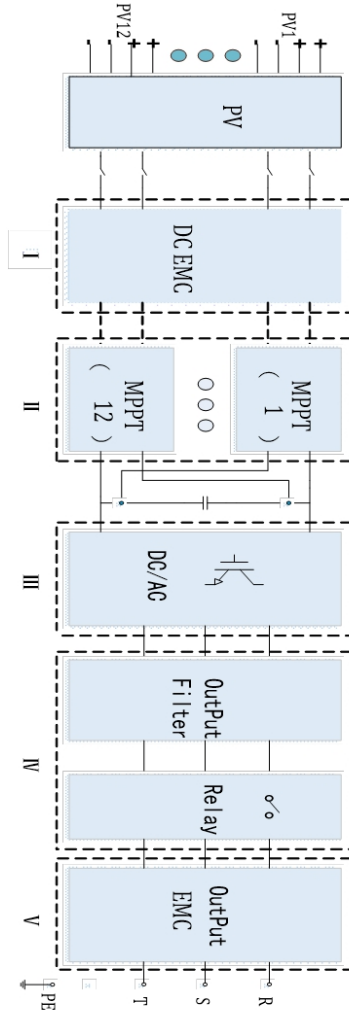

Schematic diagram

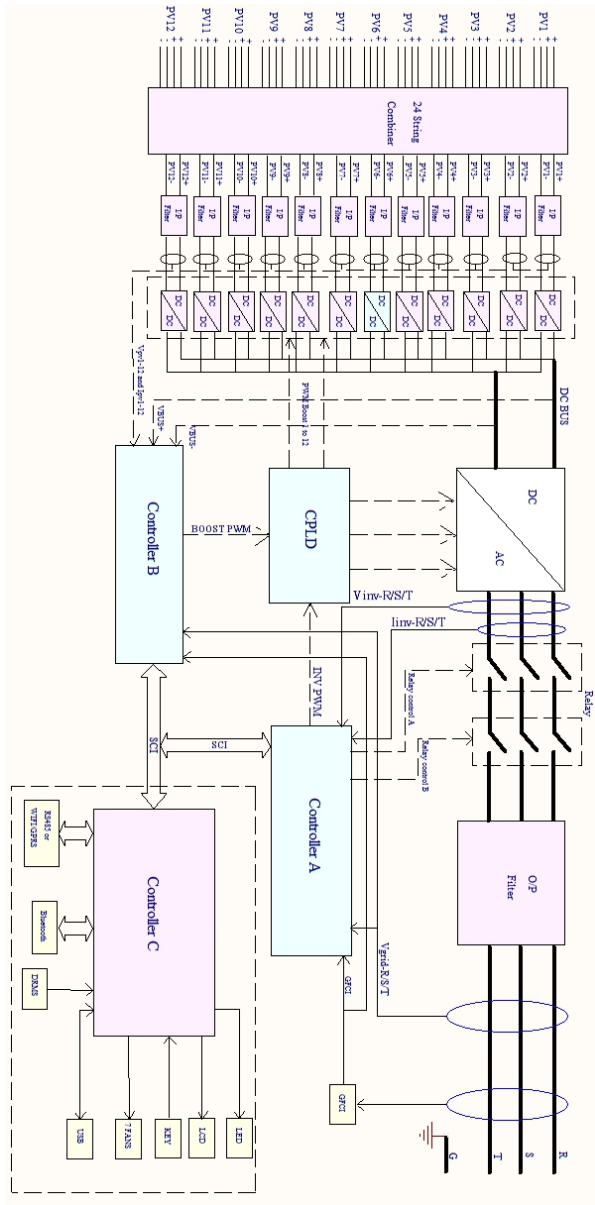

## 2.4. Efficiency and derating curve

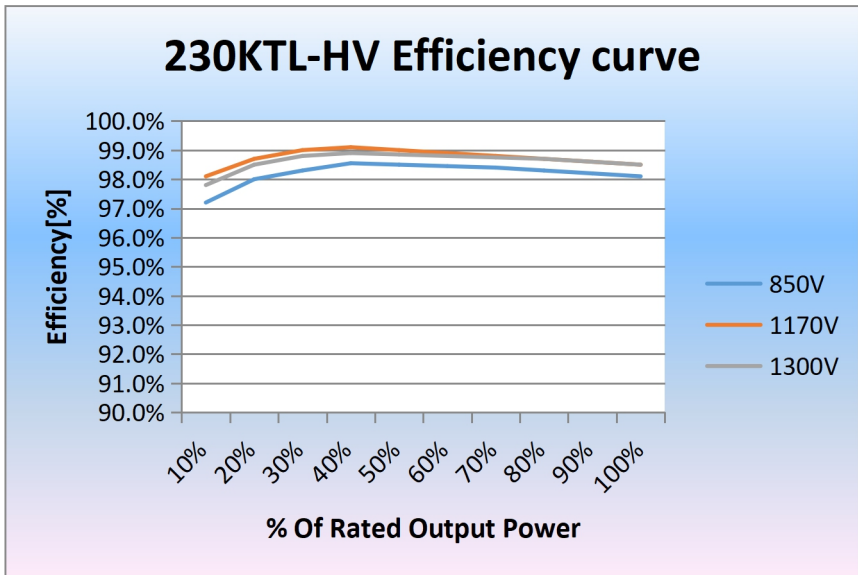
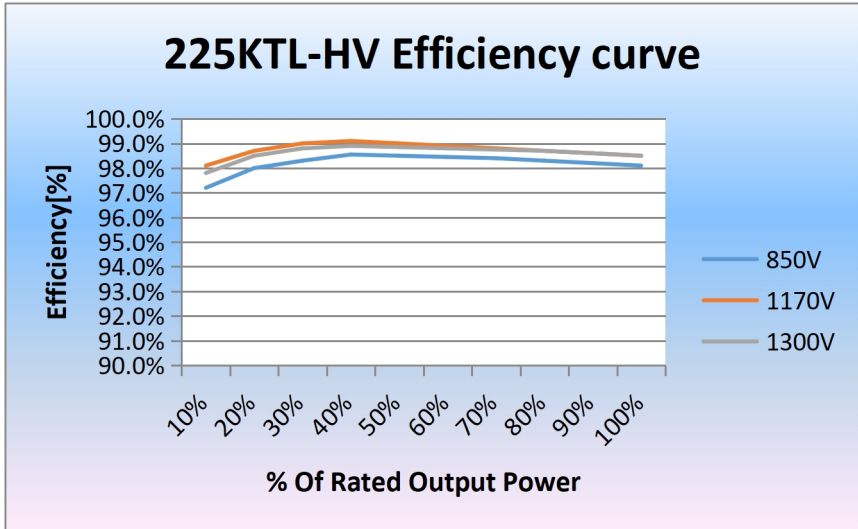



## 3. Inverter Storage

If inverter is not installing immediately, storage condition need meet below requirements:

- Place inverter into the original package and leave desiccant inside, sealed tight with taps.
- Keep the storage temperature around  $-40^{\circ}\text{C} \sim 70^{\circ}\text{C}$ , Relative humidity  $0 \sim 95\%$ , no condensation.

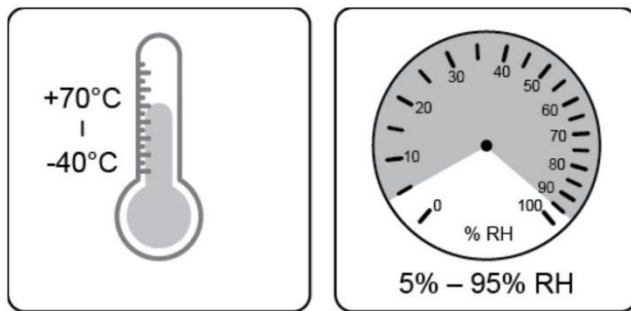





Figure 3-1 Storage temperature and humidity

- The maximum stacking layer number cannot exceed 4 layers.
- If the inverter be storage for more than half years, the inverter needs to be fully examined and tested by qualified service or technical personnel before using.

# 4. Installation

## Outlines of this Chapter

This topic describes how to install this product, please read carefully before install.

 <b>Dangers</b>	Do NOT install the product on flammable material. Do NOT store this product in potentially explosive atmospheres.
 <b>Caution</b>	The enclosure and heat sink will get hot during operation, please do not mount the product at a easy to reach location.
 <b>Attention</b>	Consider the weight of this product when doing transport and moving. Choose an appropriate mounting position and surface. At least two persons for installation.

### 4.1. Installation Process

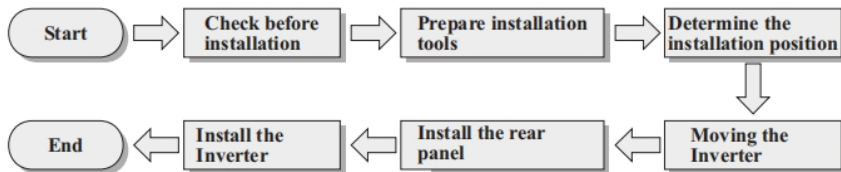

### 4.2. Checking Before Installation

#### Checking Outer Packing Materials





Before unpacking, please check the condition of the outer package materials if any damaged found, such as holes, cracks, please not unpack the product, contact your distributor immediately. Recommend installing the product within 24 hours after unpacking the package.

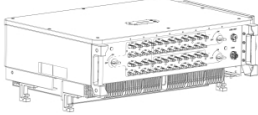

#### Checking Deliverable

After unpacking, please check according to following table, to see whether all the

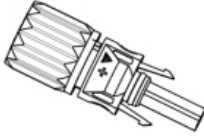
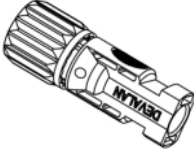
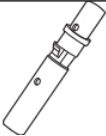
parts were included in the packing, please contact your distributor immediately if anything missing or damage.

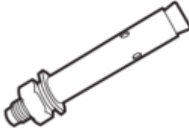
Table 4-1 Components and mechanical parts that inside the package

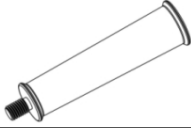
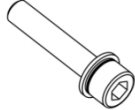
No	Pictures	Description	Quantity
1		SOFAR 250/255KTL-HV	1 PCS
2		Rear Panel	1 PCS
3		PV+ input connector	24PCS
4		PV- input connector	24PCS
5		PV+ metal pin	24PCS
6		PV- metal pin	24PCS
7		M10*90Hexagon screws	4 PCS

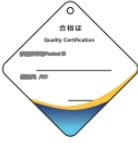
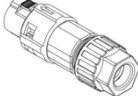
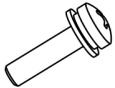



8		Auxiliary Handle	4 PCS
9		M6*30 Hexagon screws	2 PCS
10		Manual	1PCS
11		Warranty Card	1PCS
12		Quality Certificate	1PCS
13		COM 16pin connector	1PCS
14		M4X14 Cross round head triple set screw (Only for DC switch lock)	1pcs



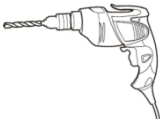

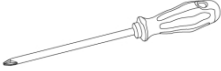
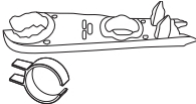
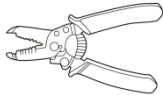
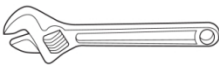
### 4.3. Tools

Prepare tools required for installation and electrical connection as following table:

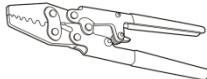
Table 4-2 Installation tools

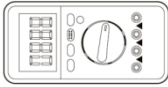
No	Tool	Description	Function
1		Hammer Drill Recommend drill @ 10mm	Used to drill holes on the wall

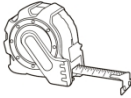
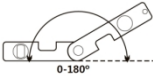
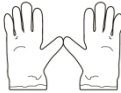
2		Screwdriver	<p>Use to tighten and loosen screws when installing AC power cable</p> <p>Use to remove AC connectors from the product</p>
3		Removal Tool	Remove PV Connector
4		Wire Stripper	Used to peel cable
5		With an open end of larger than or greater than 32 mm	Used to tighten expansion bolts
6		Rubber Mallet	Used to hammer expansion bolts into holes
7		M6	M6 use to uninstall and install the front top cover and down cover
8		Torque wrench	Connect AC connector
9		Crimping Tool	Use to crimp cable on grid side, load side and CT extensive cable

10		Multimeter	Check grounding cable, PV positive and negative pole
11		Marker	Mark signs
12		Measuring Tape	Measure distance
13		Level	Ensure the rear panel is properly installed
14		ESD gloves	Installer wear when installing product
15		Safety goggles	Installer wear when installing product
16		Mask	Installer wear when installing product

## 4.4. Determining the Installation Position

Select a appropriate location to install the product to make sure the inverter can work in a high efficiency condition. When selecting a location for the inverter, consider the following:

Note: Install vertical or backward tilt within 0-75°, Do not install forward or upside down!

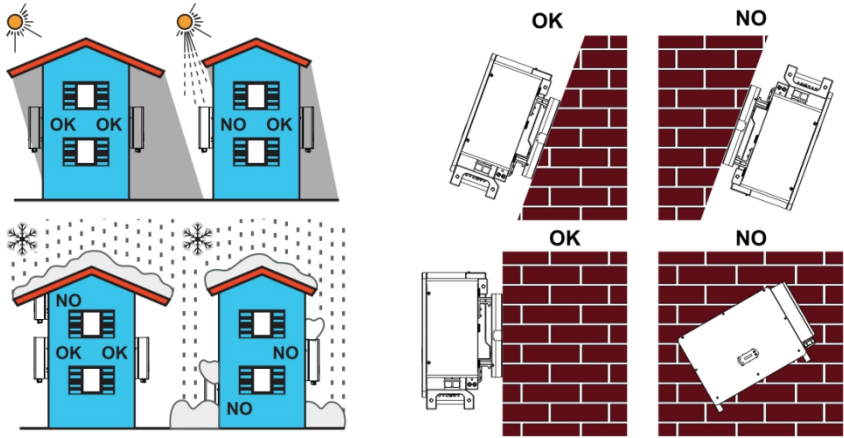

Figure 4-1 Installation Position Selection

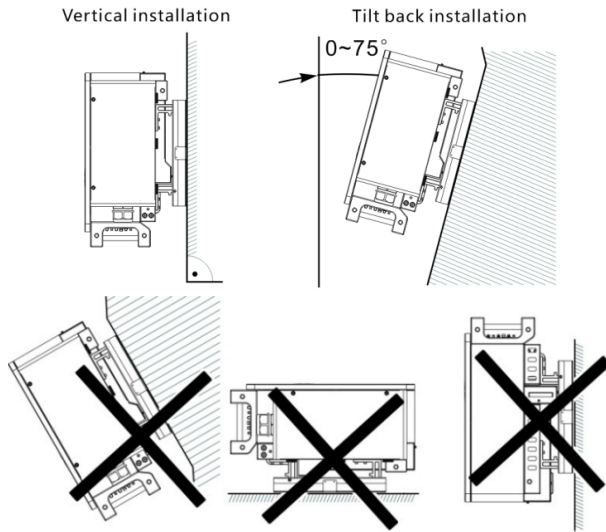
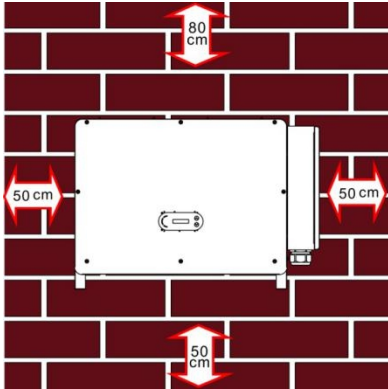

Figure 4-2 Clearance for single inverter



Note:

Other requirement for install position:

- Install position should obstruct the disconnect of power.
- Place inverter in an appropriate bearing capacity objects.
- Location should be avoid touch by children.

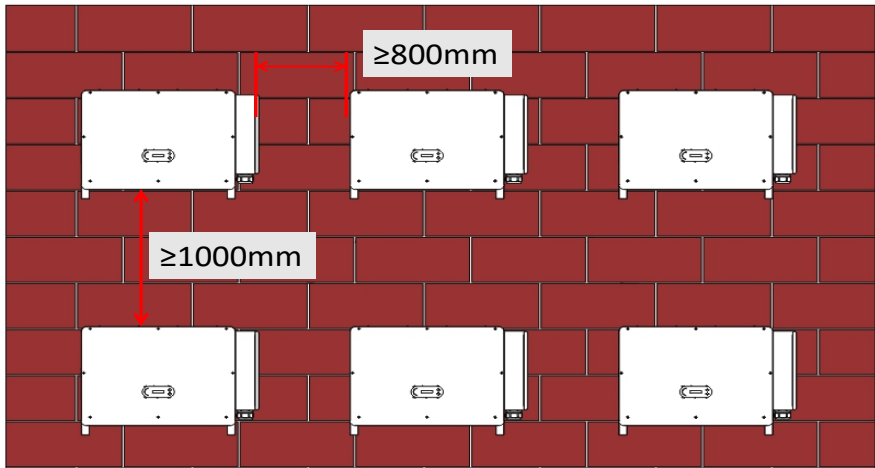



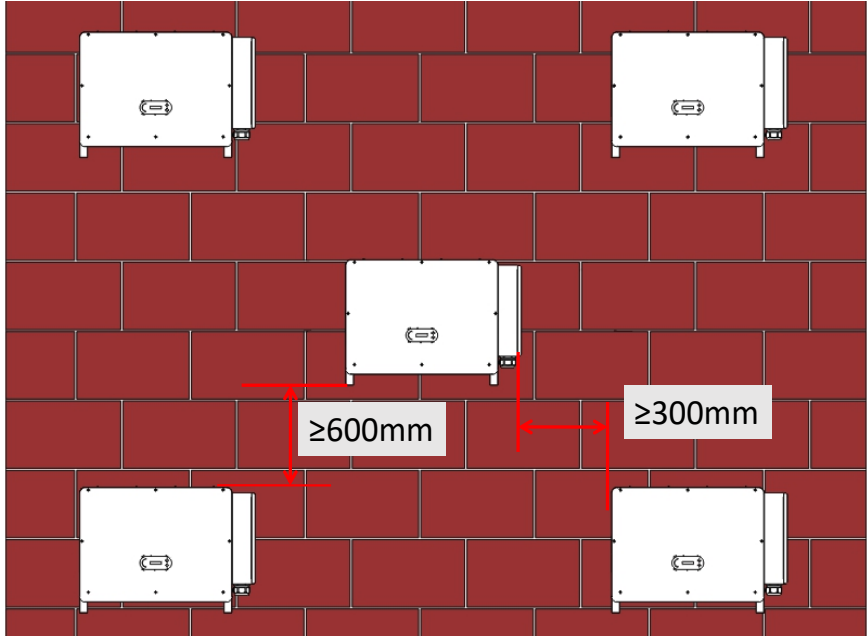

Figure 4-3 Clearance for multiple inverters

## 4.5. Moving of inverter

### 4.5.1 Manual handling

Unload the inverter from package, horizontally move to the install position. When open the package, at least two operator insert the hands into the slots on both side of the inverter and hold the handles.

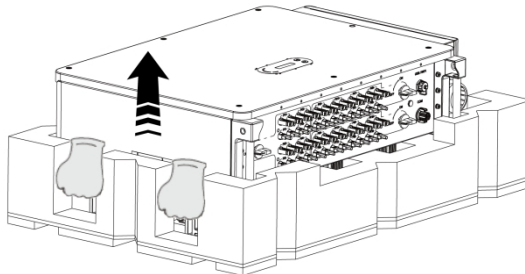



Figure 4-4 Move inverter from package

	<p>Keep the balance when lift the inverter. Required at least two operators for lifting or use forklift. Inverter is heavy, dropped while being transported may cause injuries.</p> <p>Do not put the inverter with wiring terminals contacting the floor because the power ports and signal ports are not designed to support the weight of the inverter.</p> <p>When place inverter on the floor, put it above foam or paper to avoid the damage of the shell of inverter.</p>
<p>Attention</p>	<p>Use auxiliary handle inside the package for moving the inverter. After use, keep it well for future usage.</p>

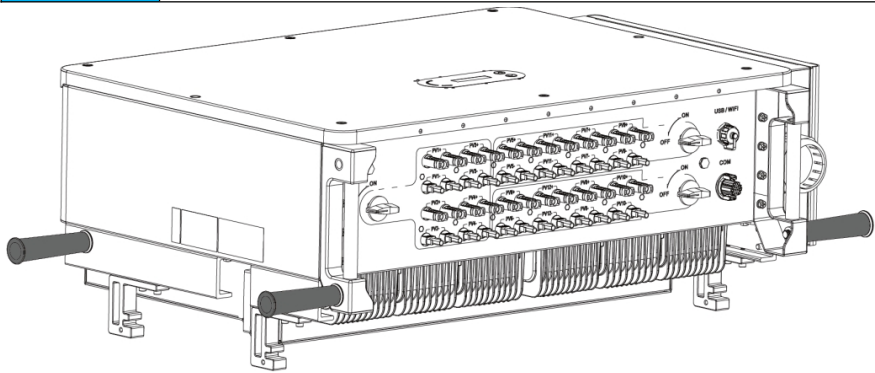

Figure 4-5 auxiliary handle position

### 4.5.2 Lifting Equipment

1. Tighten the screws of two M12 rings into the inverter sides according to the instruction diagram below (Note: M12 rings need self-preparation).

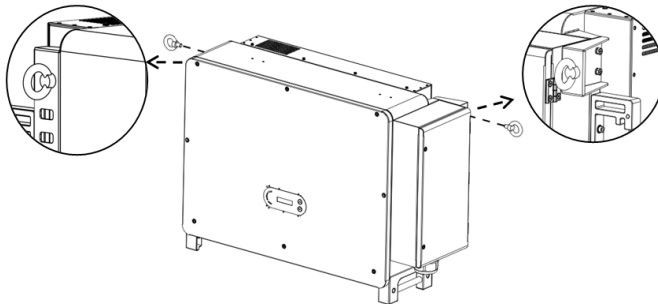
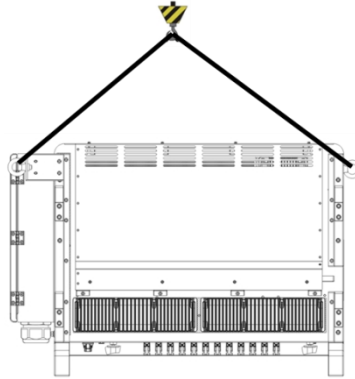



Figure 4-6 Installation of Rings

2. Fastened and tied the rope through two rings. Lifting inverter 50 mm above

ground by using lifting equipment, check the tightening device of the hoisting ring and rope. After confirming that the binding connection is secure, lift the inverter to the destination.



 <b>Attention</b>	<p>Keep balance when lifting the inverter, avoid to crash on wall or other objective.          Stop working in bad weather condition such as raining, heavy fog, winding.</p>
-------------------------------------------------------------------------------------------------------	-----------------------------------------------------------------------------------------------------------------------------------------------------------------------------------

## 4.6. Installation

### 4.6.1 Installed on wall:

Step 1: Placed the rear panel on the mounting wall, determine the mounting height of the bracket and mark the mounting poles accordingly. Drilling holes by using Hammer Drill, keep the hammer drill perpendicular to the wall and make sure the position of the holes should be suitable for the expansion bolts.

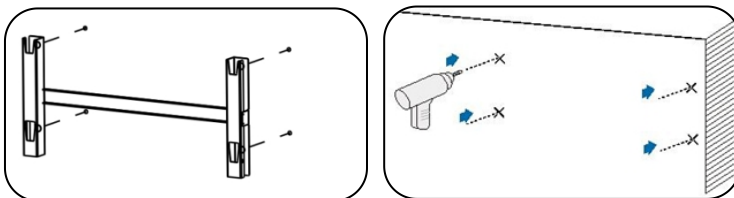

Figure 4-8 Drilling holes on the mounting wall

Step 2: Insert the expansion bolt vertically into the hole.

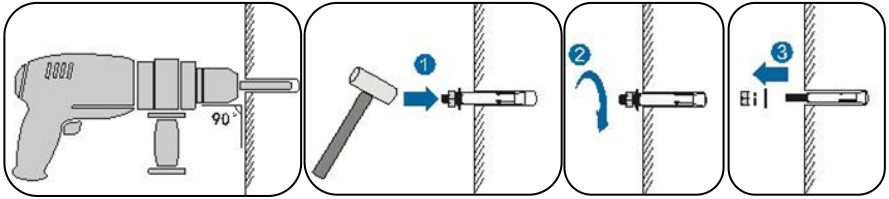

Figure 4-9 Screws into the holes

Step 3: Align the rear panel with the hole positions, fix the rear panels on the wall by tightening the expansion bolt with the nuts.

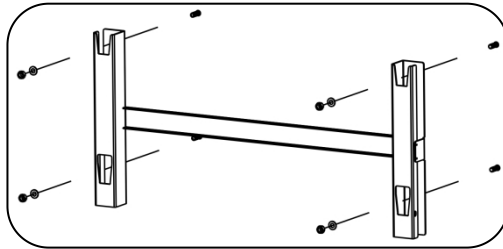
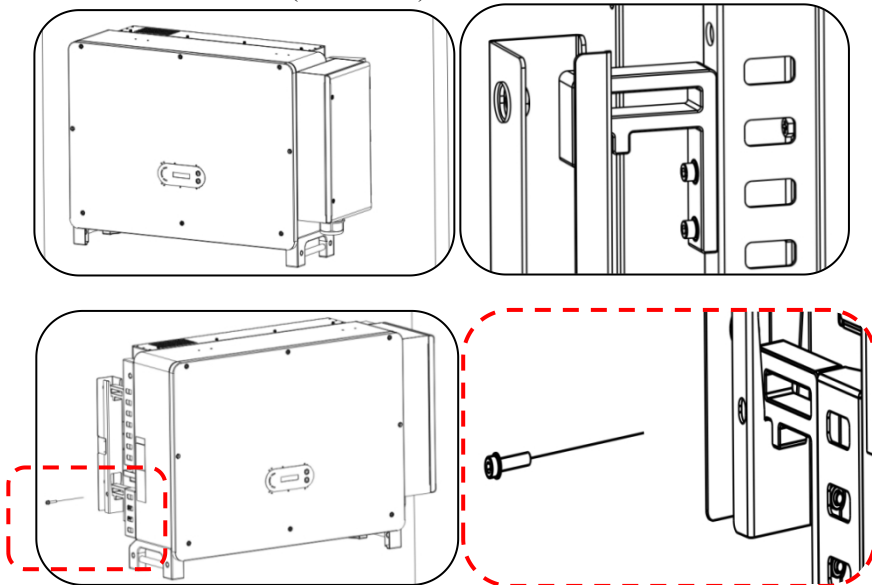

Figure 4-10 Install rear panel

Step 4: Lift the inverter and hang it on the rear panel, and fixing both side of inverter with M6 screw (accessories).



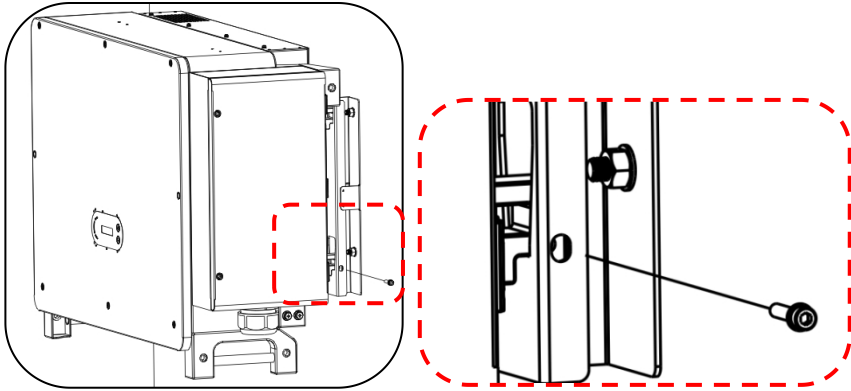

Figure 4-11 Fix inverter

### 4.6.2 Bracket Installation :

Step 1: Use wall mount bracket, ensure the pole position are in same level by using level rule and take a mark with maker.

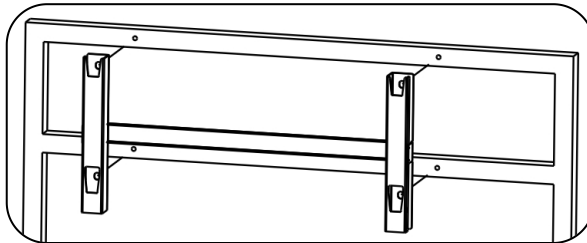

Figure 4-12 Ensure hole position

Step 2: Drilling hole by using Hammer Drill, recommend to do a stain proofing.

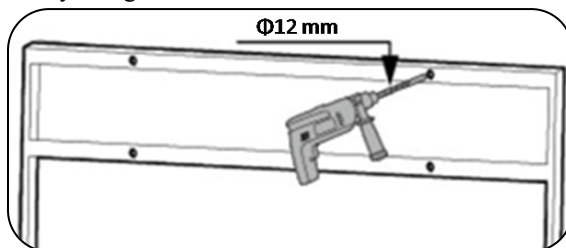

Figure 4-13 Drilling holes

Step 3: Use M10 screw and M10 flat washer to secure the wall bracket (Note : M10\*50 screw and M10 flat washer need self-preparation) .

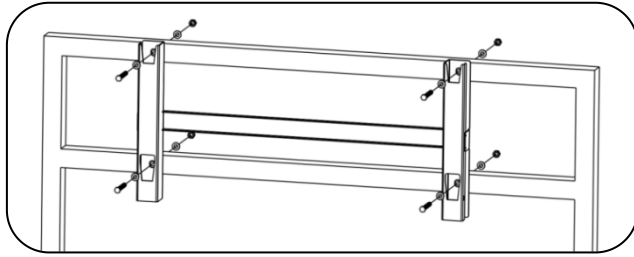
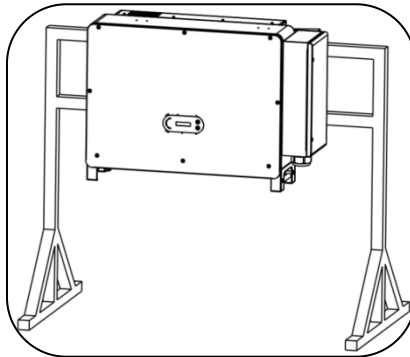

Figure 4-14 Fix wall bracket

Step 4: Lift the inverter and hang it on the wall bracket, and fixing both side of inverter with M6 screw (repeat 4.6.1 step 4) .



Note: If height between ground and bracket is less than 1.3m, use auxiliary handle for installation. Otherwise, use lifting equipment.

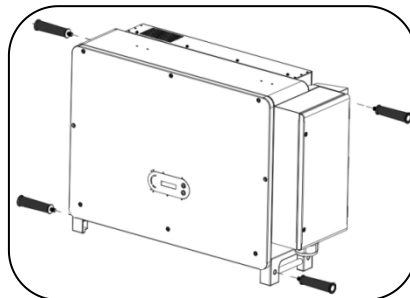

Figure 4-15 Installation position of auxiliary handle



# 5. Electrical Connection

## Outlines of this Chapter

This section introduces the electrical connection for the product. Please read the information carefully, it may helpful to understand the grounding wiring, DC input connection, AC output connection and communication connection.

**Caution:**

Before performing electrical connections, ensure the DC switch is OFF and AC circuit breaker is OFF. Waiting 5 minutes for the capacitor to be electrically discharged.

	<p>Installation and maintenance should be done by certified electrical engineer.</p>
<p>Attention</p>	
	<p>Before the electrical connection, use opaque material to cover the PV modules or disconnect PV string DC switch. PV arrays will produce dangerous voltage if it is exposure under sun.</p>
<p>Danger</p>	
	<p>For this product, the open circuit voltage of PV strings should not greater 1500V.</p>
<p>Note</p>	

### 5.1 Electrical Connection

Introduce the electrical connection process.

### 5.2 Terminal Port

Introduce inverter terminal port layout.

### 5.3 Grounding Protection (PE)

Connect PE line for grounding protection.

### 5.4 Connect AC output (AC-Output)

Connect AC output for feeding generated electrical into the utility grid. Must meet the requirement of local utility grid company.

### 5.5 DC input connection

Connect PV array with inverter by DC cable.

### 5.6 Communication Connection

Introduce the propose WIFI/USB, COM and how to connect WIFI/USB port.

### 5.7 Safety check

Before operate inverter, check the PV array, inverter DC side safety connection and AC side safety connection.

## 5.1. Electrical Connection

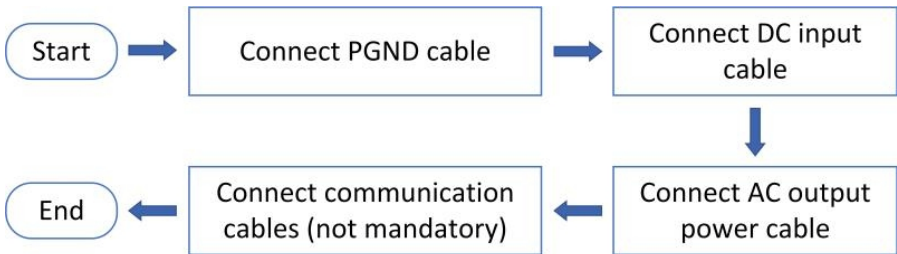
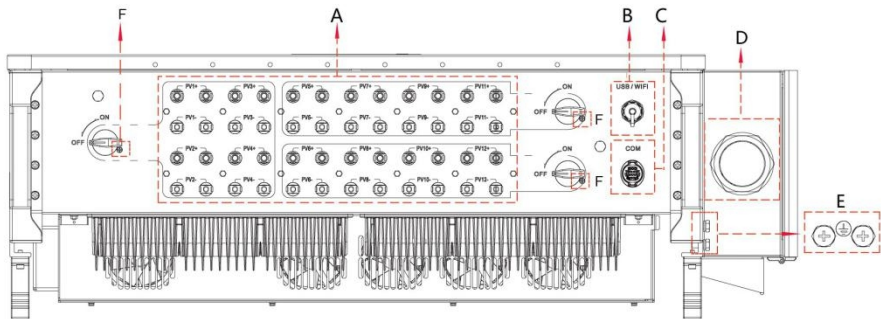

Figure 5-1 Flowchart for connecting cables to the inverter

## 5.2. Terminal Connector

Connector description as below:



\*Take picture as reference

No	Name		Description
A	DC input terminals	PVX+/PVX-	PV connector
B	USB/WIFI port	USB/WIFI	For WIFI,GPRS Communication



C	RS485 Modbus/DRMs	RS485/DRMs	RS485 Communication port/DRMs port
D	AC output terminals		AC output terminal
E	Grounding		Connecting terminal of the ground , choose at least one for grounding connection
*F	DC switch lock		For Australian models

\*Note: Lock the screw to limit the torque of the DC switch, making it impossible to twist the DC switch from OFF to ON, or ON to OFF. Remove the screw before turning the DC switch from OFF to ON or ON to OFF.

### 5.3. Grounding Connection (PE)

Connect the inverter to the grounding electrode using ground cable

	SOFAR 250/255KTL-HV is a transformerless inverter which requires the positive pole and negative pole of the PV array are NOT grounded. Otherwise, it will cause inverter failure. In the PV system, all non-current-carrying metal parts (such as mounting frame, combiner box enclosure, etc.) should be connected to earthed.
Note	

**Preparation: prepare the grounding cable (recommend 16mm<sup>2</sup> yellow-green outdoor cable and M8 OT Terminal)**

**Procedure:**

Step 1: Remove the insulation layer with an appropriate length using a wire stripper shown as figure 5-2) .

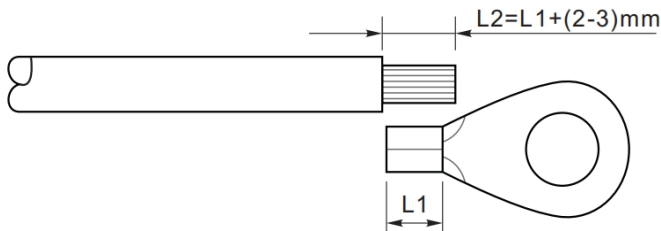

Figure 5-2 Grounding connection instruction (1)

Note: The length of L2 should 2~3mm higher than L1.

Step 2: Insert the exposed core wires into the OT terminal and crimp them by using a crimping tool, as shown as figure 5.3. Recommend using OT terminal:

OTM6, Cable:  $\geq 6\text{mm}^2$ .

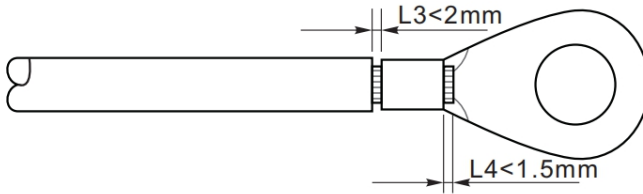
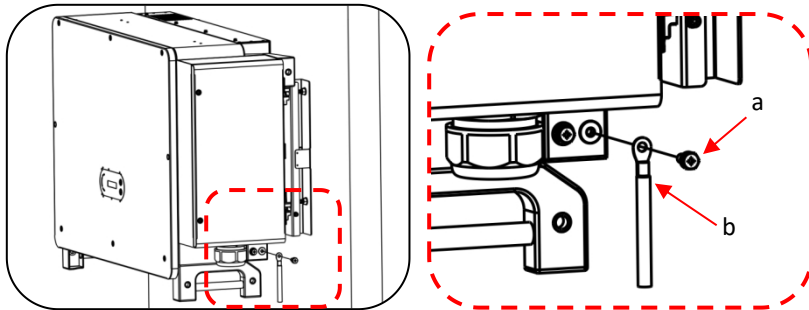

Figure 5-3 Grounding connection instruction (2)

**Note 1:** L3 is the length between the insulation layer of the ground cable and crimped part. L4 is the distance between the crimped part and core wires protruding from the crimped part.

**Note 2:** The cavity formed after crimping the conductor crimp strip shall wrap the core wires completely. The core wires shall contact the terminal closely.

Step 3: Remove the screw from the bottom side of inverter (Shown as figure 5-4), connect the grounding cable to the grounding point and tighten the grouping screw. Torque is 6-7N.m.



a.M8hexagon screw b. grounding cable

Figure 5-4 Inverter external grounding instruction diagram

**Note:** For improving anti-corrosion performance, after ground cable installed, apply silicone or paint is preferred to protect.

## 5.4. Connect grid side of inverter(AC-Output)

Inverter has a standard and integrated residual current monitoring unit (RCMU), when inverter detected leakage current excess 300mA, it will cut off with utility

grid for protection. For external Residual Current Device (RCD), the rated residual current shall be 300mA or higher.

Precondition:

Inverter AC side should connect a three phase circuit current to ensure inverter can be cut off with utility grid for abnormal condition.

The AC cable need to meet the requirement of local grid operator.

### 5.4.1 Open the wiring box

**Note :**

- Forbid to open then main board cover of inverter.
- Before open the wiring box, please ensure there is not DC and AC connection.
- If open the wiring box on snowing or raining day, please take protective measures to avoid the snow and rain enter wiring box. Otherwise, should not open the wiring box.
- Please do not unused screw in the wiring box.

Step 1: Use M6 driver to unscrew the two screws on the wiring box.

Step 2: Open wiring box cover.

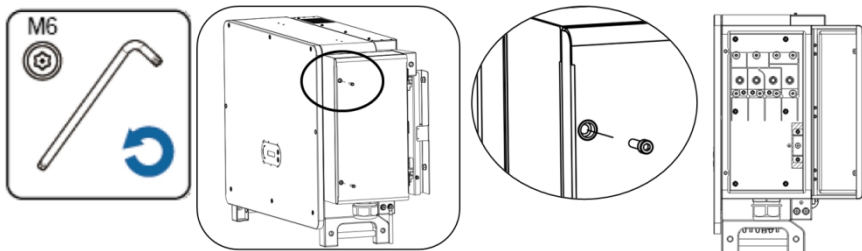

Figure 5-5 Open wiring box

### 5.4.2 Wiring Terminal and Precautions

**Note:**

- Before connect to grid, please ensure the grid voltage and frequency of local grid meet the requirement of inverter , any question please seek local grid company for help.
- Inverter can only connect to grid after get the permission from local grid

company.

- Should not connect any loads between inverter and AC circuit breaker.
- OT/DT Requirement.
- When use copper core cable, please use copper terminal connector.
- When use copper clad aluminum cable, please use copper terminal connector.
- When use aluminum core cable, please use Copper and aluminum transition terminal connector or aluminum terminal connector.

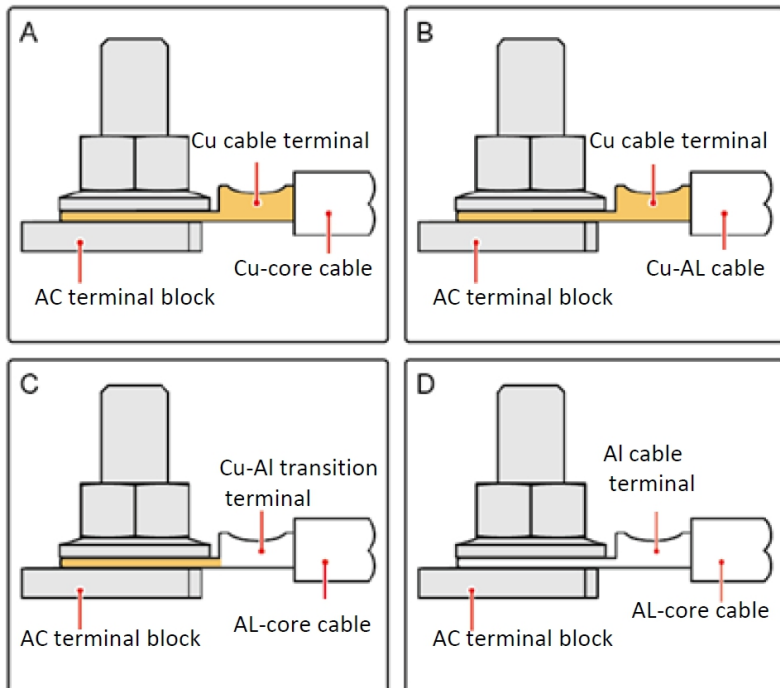

Figure 5-6 OT/DT Requirement for terminal connection

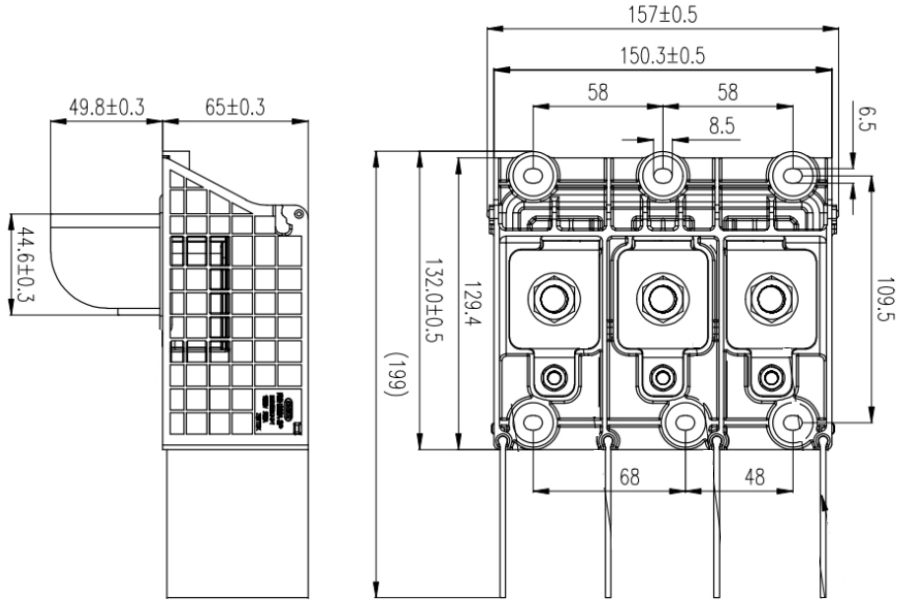

Figure 5-7 AC Terminal size

## 5.4.4 Wring Procedure

The section will use a five core wire as a sample, four core wire has same connection process.

Table 5-1 Recommend AC cable size

Name	Type	Area(mm <sup>2</sup> )
AC Cables	Recommended: Outdoor four-core/five-core copper or aluminum wire	Copper Wire: 95~185; Aluminum Wire: 120~240; PE Wire: reference 5.3

Step 1: Open the cover, refers to section 5.3.1.

Step 2: Turn OFF the AC circuit breaker and secure against reconnection.

Step 3: Unscrew the nut of the AC terminal block and select the sealing ring according to the outer diameter of the cable. Insert the nut, sealing ring into the cable in sequence.

Step 4: Remove the insulation layer of an appropriate length according to figure below.

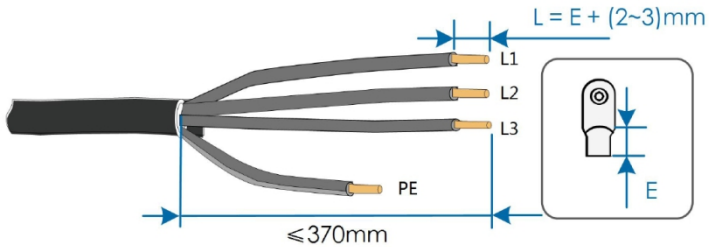

Step 5: Crimp the terminal.

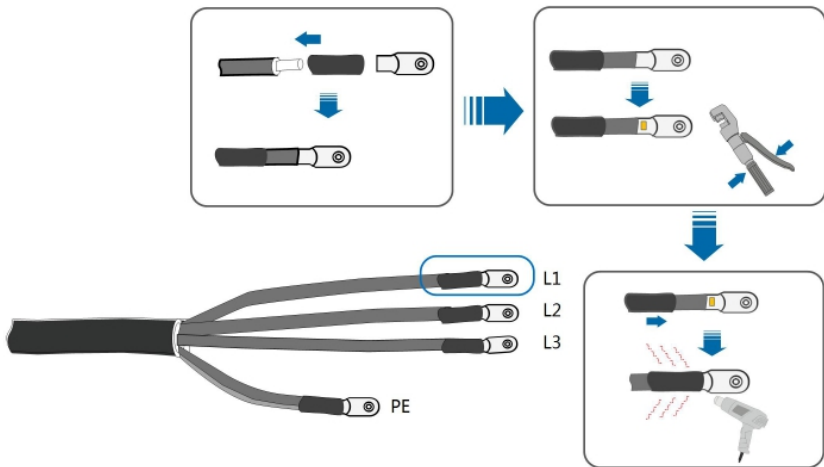

Step 5: Depending on the grid configuration, connect L1, L2, L3 and N to the terminals according to the label and tighten the screw on the terminal using a screwdriver.

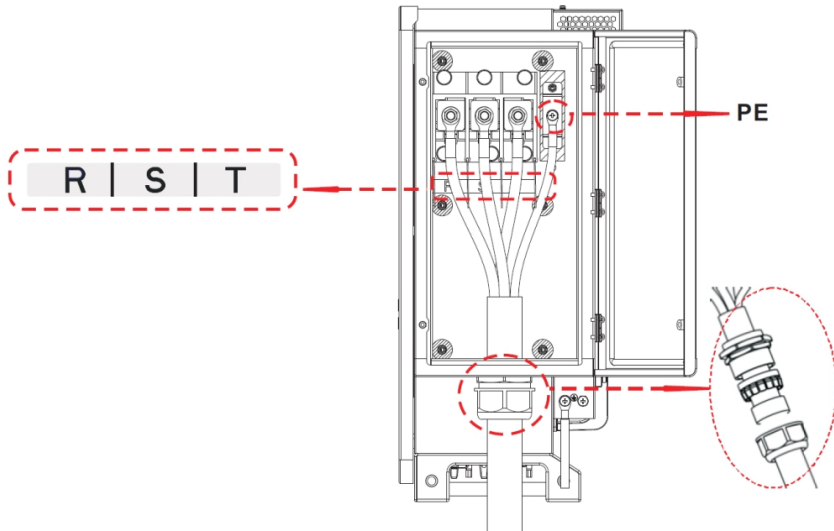

**Note:**

- Phase lines use M12 terminal connector, PE line use M8 terminal connector.

## 5.5. Connect PV side of inverter (DC-Input)

**Note:**

- Connecting PV strings into inverter must following the below procedure. Otherwise, any faulty cause by inappropriate operation will be including in the warranty case.
- Ensure the maximum short circuit current of PV strings should less than the maximum inverter DC current input. And three “DC switch” is in OFF position. Otherwise, it may cause high voltage and electric shock.
- Ensure PV array have good insulation condition in any time.
- Ensure same PV string should have the same structure, including: same model, same number of panels, same direction, same azimuth.
- Ensure PV positive connector connect to inverter positive pole, negative conector connect to inverter negative pole.
- Please use the connectors in the accessories bag. The damage cause by incorrect is not including in the warranty.

Table 5-2 Recommend DC cable size

Copper cable cross section area (mm <sup>2</sup> )		Cable OD(mm)
Range	Recommend	
4.0~6.0	4.0	4.5~7.8

Step 1: Find the metal contact pins in the accessories bag, connect the cable according below diagram (1.Positive cable, 2. negative cable).

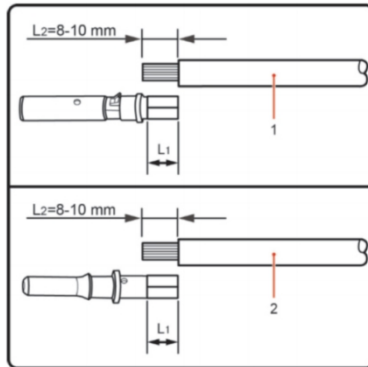
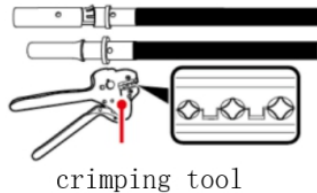

Figure 5-8 DC cable connection (1)

Step 2: Crimp the PV metal contact pin to the striped cable using a proper crimping pliers.



Step 3: Insert wire into the connector cap nut and assemble into the back of male or female plug, When you heard a “click”, the pin tact assembly is seated correctly. (3. Positive Connector, 4. negative connector).



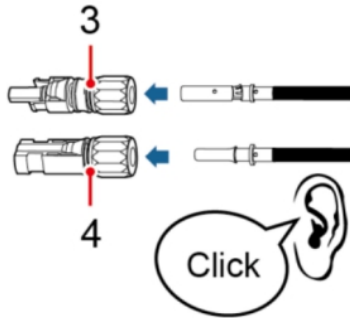

Step 4: Measure PV voltage of DC input with multimeter, verify DC input cable polar and connect DC connector with inverter until hearing a slight sound indicated connection succeed.

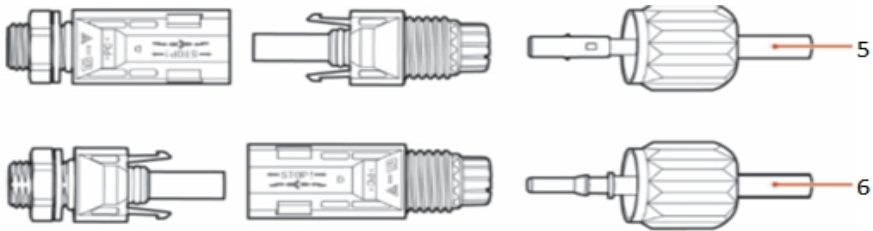
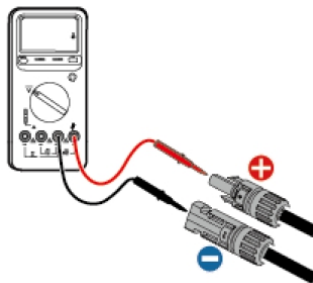



Figure 5-9 DC cable connection



**Note :** Please use multimeter to make sure the PV array positive pole and negative pole!

Dealing : If need to remove the PV connector from inverter side, please use the Removal Tool as below diagram, move the connector gently.

 <b>NOTE</b>	<p>Before, moving the positive and negative connector, please make sure “DC Switch” is on OFF position.</p>
----------------------------------------------------------------------------------------------------	-------------------------------------------------------------------------------------------------------------

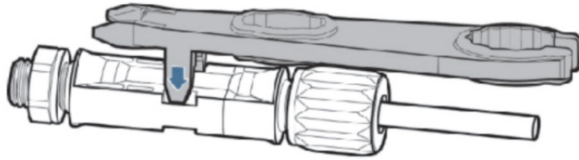

Figure 5-10 Removal DC connector

## 5.6. Communication Connection

**Note:** When layout the wiring diagram, please separate the communication wiring and power wiring in case the signal be affected.

### 5.6.1 USB/WIFI Port

Port Description:

USB/WIFI port	USB: USB Port	Use for updating the software
	WIFI: WIFI Port	Use for connect Wi-Fi for data transmission.

Procedure:

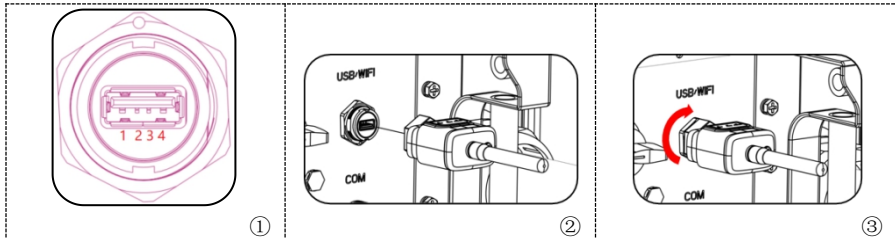

### 5.6.2 COM—Multi function communication port

Table 5-3 Recommend com cable size

Name	Type	Outer diameter(mm)	Area (mm <sup>2</sup> )
RS485 Communication Wire	Outdoor shielded twisted pair meets local standards	3core: 4~8	0.25~1

Port Description:

PIN	Define	Function	Note
1	RS485A	RS485 signal+	Wire connection

2	RS485A	RS485 signal+	monitoring or multiple inverter monitoring
3	RS485B	RS485 signal-	
4	RS485B	RS485 signal-	
5	Electric meter RS485A	Electric meter RS485 signal+	Wire connection Electric meter
6	Electric meter RS485B	Electric meter RS485 signal-	
7	GND.S	RS485 signal ground	
8	DRM0	Remote shunt down	DRMS port
9	DRM1/5	Reserve	
10	DRM2/6	Reserve	
11	DRM3/7	Reserve	
12	DRM4/8	Reserve	
13	GND.S	Communication Ground	
14-16	Blank PIN	N/A	N/A

## Procedure:

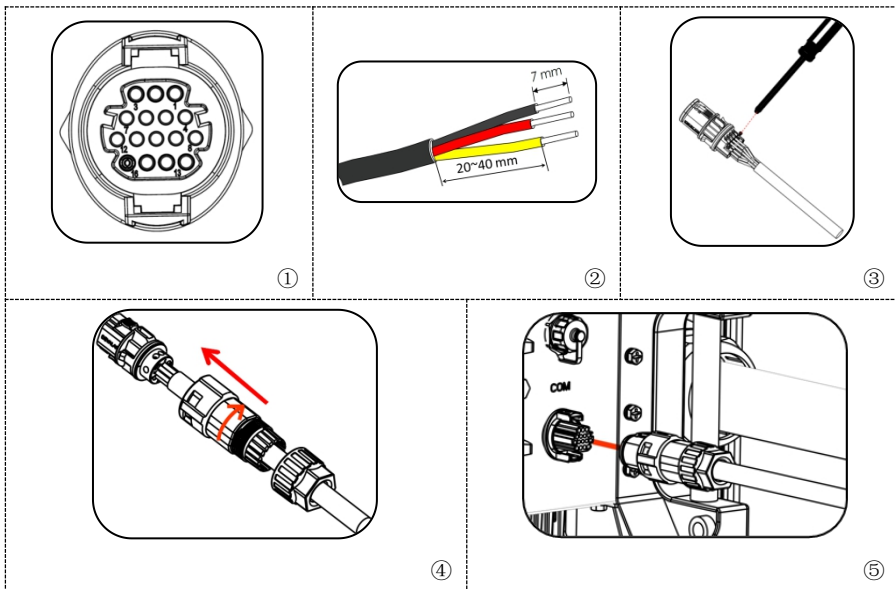

# 6. Commissioning of inverter

## Outlines this Chapter

Introduce SOFAR 250/255KTL-HV safety inspection and start processing.

### 6.1. Cable Connection Inspection



#### Attention

For first time operation, check the AC voltage and DC voltage are within the acceptable range.

AC grid connection

Use multimeter to confirm that three lines and PE line are connect correctly.

DC pv connection

Use multimeter to confirm that positive pole and negative pole of PV strings, and the Voc of each string is lower than the inverter max DC input.

### 6.2. Start Inverter

**Step 1:** Turn ON the DC switch.

**Step 2:** Turn ON the AC circuit breaker.

When the DC power generated by the solar array is enough, the SOFAR 250/255KTL-HV inverter will start automatically. Screen showing “normal” indicates correct operation.

**NOTE 1:** Choose the correct country code. (refer to section 7.3 of this manual).

**NOTE 2:** Different distribution network operators in different countries have different requirements regarding grid connections of PV grid connected inverters.

Therefore, it's very important to make sure that you have selected the correct country code according to requirements of local authority. Please consult qualified electrical engineer or personnel from electrical safety authorities about this.

Shenzhen SOFARSOLAR Co., Ltd. is not responsible for any consequences arising out of incorrect country code selection.

If the inverter indicates any fault, please refer to Section 8.1 of this manual —— trouble shooting for help.

# 7. Operation interface

## Outlines of this chapter

This section introduces the display, operation, buttons and LED indicator lights of SOFAR 250/255KTL-HV Inverter.

### 7.1. Operation and Display Panel

#### Buttons and Indicator lights

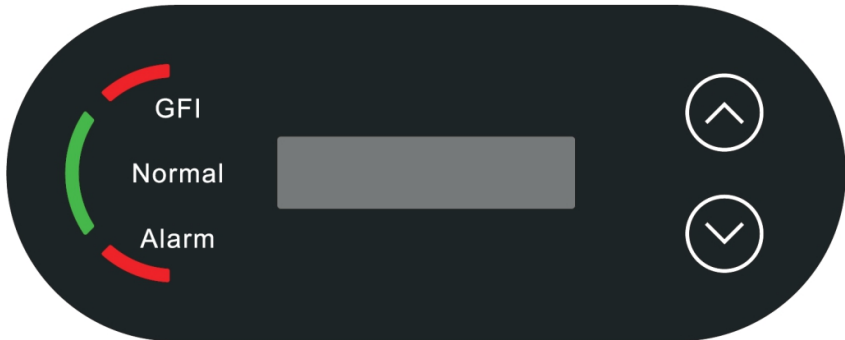

#### Button:

- “^” Short press UP button = go up
- “^” Long press UP button = exit current interface
- “v” Short press DOWN button = go down
- “v” Long press DOWN button = enter current interface

#### Indicator Lights:

- “GFI” Red light ON = GFCI faulty
- “Normal” Green light flashing = counting down or checking
- “Normal” Green light ON = Normal
- “Alarm” Red light ON = recoverable or unrecoverable faulty

## 7.2. Standard Interface

LCD interface indicated inverter status, alarm information, communication connection, PV input current and voltage, grid voltage, current and frequency, today generation, total generation.

Inverter working status, PV 1 -12 PV input voltage and current



Inverter working status, PV generated power

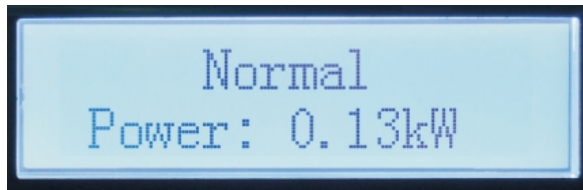

Inverter working status, today generated electricity

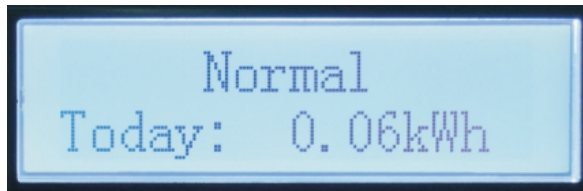

Inverter working status, total generated electricity

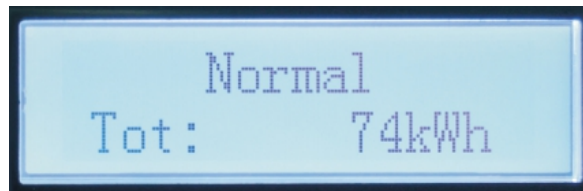

Inverter working status, grid voltage and current

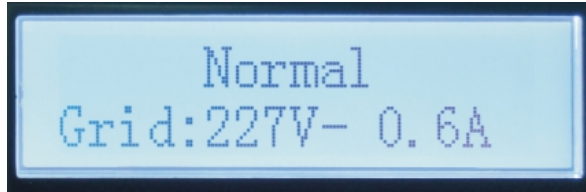

Inverter working status, grid voltage and frequency

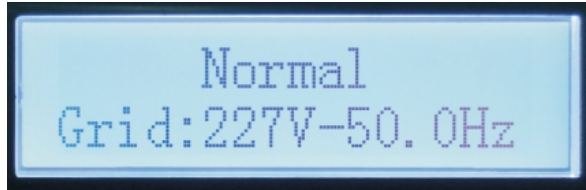

Inverter working status, Wi-Fi/ RS485 status

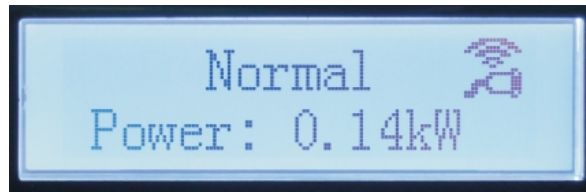

Inverter faulty alarm



When power turn on, LCD interface displays Initializing, refer below picture.



When control board successfully connected with communication board, the LCD display the current state of the inverter, display as shown in the figure below.



● Waiting States, Countdown 10S  
(depends country code, some are 60s)

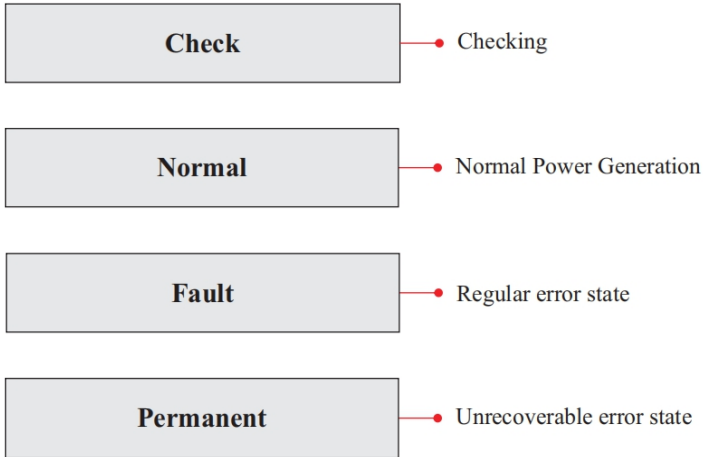

Inverter states includes: wait, check, normal, fault and permanent.

**Wait:**Inverter is waiting to Check State when reconnect the system. In this state, grid voltage value is between the max and min limits and so on; If not, Inverter will go to Fault State or Permanent State.

**Check:** Inverter is checking isolation resistor, relays, and other safety requirements. It also does self-test to ensure inverter software and hardware are well functional. Inverter will go to Fault State or Permanent State if any error or fault occurs.

**Normal:** Inverter enter to Normal State, it is feeding power to the grid; inverter will go to Fault State or Permanent state if any error or fault occurs.

**Fault:**Fault State: Inverter has encountered recoverable error. It should recover if the errors disappear. If Fault State continues; please check the inverter according error code.

**Permanent:**Inverter has encountered unrecoverable error, we need maintainer debug this kind of error according to error code.

When the control board and communication board connection fails, the LCD display interface as shown in the figure below.





### 7.3. Main Interface

Long press the down button under standard interface to enter into main interface, Main interface including below information:

Normal	-----Long press DOWN button	
	<b>1.Enter Setting</b>	
	<b>2.Event List</b>	
	<b>3.SystemInfo</b>	
	<b>4.Display Time</b>	
	<b>5.Software Update</b>	

(A)Enter setting Interface as below:

1.Enter Setting	-----Long press DOWN button	
	<b>1.Set time</b>	<b>7.Set Address</b>
	<b>2.Clear Energy</b>	<b>8.Set Input mode</b>
	<b>3.Clear Events</b>	<b>9.Set Language</b>
	<b>4.Country Country</b>	<b>10.Set RefluxP</b>
	<b>5.On-Off Control</b>	<b>11.Logic Interface</b>
	<b>6.Set Energy</b>	<b>12.IV Curve Scan</b>

Long press the button to Enter the main interface of "1.Enter Setting" and long press to enter the setting menu. You can select the content you want to set by short pressing the button.

Note1: Some settings need to enter the password (the default password is 0001), when entering the password, short press to change the number, long press to confirm the current number, and long press after entering the correct password.If "password error, try again" appears, you will need to re-enter the correct password.

#### 1. Set Time

Set the system time for the inverter.

#### 2. Clear Energy

Clean the inverter of the total power generation.

#### 3. Clear Events

Clean up the historical events recorded in the inverter.

#### **4. Country Country**

Long press button, enter interface, save the specific file into USB and insert USB into inverter communication port.

#### **5. On-Off Control**

Inverter on-off local control.

#### **6. Set Energy**

Set the total power generation. You can modify the total power generation through this option.

#### **7. Set address**

Set the address (when you need to monitor multiple inverters simultaneously), Default 01.

#### **8. Set Input mode**

SOFAR 250/255KTL-HV has 8-12 MPPTs, these MPPTs can work interdependently, or divided into parallel mode. User can change the setting according to the configuration.

#### **9. Set Language**

Set the inverter display language.

#### **10. Set RefluxP**

The reflux power value set by the anti-reflux function is the maximum power value allowed to be transmitted to the grid.

#### **11. Logic interface**

Enable or disable logical interfaces. It is use for below standard Australia (AS4777), Europe General (50549), German(4105).

#### **12. MPPT Scan**

Shadow scanning, when the component is blocked or abnormal, causing multiple power peaks, by enabling this function, the peak point of maximum power can be tracked.

##### **(B) Event List:**

Event List is used to display the real-time event records, including the total number of events and each specific ID No. and happening time. User can enter Event List interface through main interface to check details of real-time event

records, Event will be listed by the happening time, and recent events will be listed in the front. Please refer to below picture. Long press the button and short press the button to turn the page in standard interface, then enter into “2.Event List” interface.

2. Event List	
1. Current event	2. History event
Fault information	001 ID04 06150825 (Display the event sequence number, event ID number, and event occurrence time )

(A) “SystemInfo” Interface as below

<b>3.SystemInfo</b>	-----Long press DOWN button	
	<b>1.Inverter Type</b>	<b>7.Input Mode</b>
	<b>2.Serial Number</b>	<b>8.Remote State</b>
	<b>3.Soft Version</b>	<b>9.Reflux Power</b>
	<b>4.Hard Version</b>	<b>10.DRM<sub>s0</sub></b>
	<b>5.Country</b>	<b>11.DRM<sub>n</sub></b>
	<b>6.Modbus Address</b>	<b>12.MPPT Scan</b>

The user enters the main menu by long pressing the DOWN button, short press and turns the page to select menu contents, then long press the button to enter "3. SystemInfo". Turning the page down can select the system information to view.

(B) Display Time

Long press the button and short press the button to turn the page in the standard user interface to enter into “4.Display Time”,then long press the button to display the current system time.

(C) Software Update

User can update software by USB flash drive , SOFARSOLAR will provide the new update software called firmware for user if it is necessary,The user needs to copy the upgrade file to the USB flash drive.

## 7.4. Updating Inverter Software

SOFAR 250/255KTL-HV inverter offer software upgrade via USB flash drive to maximize inverter performance and avoid inverter operation error caused by

software bugs.

**Step 1:** Turn off AC circuit breaker and DC switch, remove the communication board cover as below figure. If the RS485 line has been connected, please release the waterproof nut first and make sure the communication line is no longer the force. Then remove the waterproof cover.

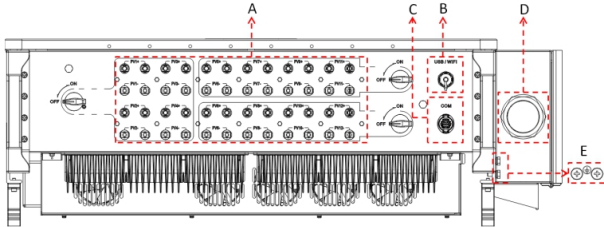

Figure 7-1 Remove communication board cover

**Step 2:** Insert USB into computer.

**Step 3:** SOFARSOLAR service team will send the software code to user, After user receive the file, please decompressing file and cover the original file in USB flash drive.

**Step 4** Insert USB drive into the USB port of inverter.

**Step 5** Then turn on DC switch and enter into the online upgrade to the main menu"5.Software Update"in the LCD display program[6.3(E)].The method to enter the menu can refer to operation interface of LCD.

**Step 6** Input the password,if password is correct,and then begin the update process,the original password is 0715.

**Step 7** System update main DSP, slave DSP and ARM in turns.If main DSP update success,the LCD will display"Update DSP1 Success", otherwise display "Update DSP1 Fail";If slave DSP update success,the LCD will display"Update DSP2 Success",otherwise display "UpdateDSP2 Fail".

**Step 8** If Fail,please turn off the DC switch, wait for the LCD screen turn off, then turn on the DC switch again,then Continue to update from step 5.

**Step 9** After the update is completed,turn off the DC breaker, wait for the LCD screen extinguish,then recover the communication waterproof and then turn on the DC breaker and AC breaker again,the inverter will enters the running state. User can check the current software version in SystemInfo>>>3.SoftwareVersion.

# 8. Trouble shooting and maintenance

## 8.1. Troubleshooting

This section describes the potential errors for this product. Please read carefully for the following tips when doing the troubleshooting:

- 1) Check the warning message or faulty codes on the inverter information panel
- 2) If not any error code display on the panel, please check the following lists:
  - Is inverter be installed in a clean, dry, ventilated environment?
  - Is the DC switch turn off?
  - Are the cable cross section area and length meet the requirement?
  - Are the input and output connection and wiring in good condition?
  - Are the configuration settings correctly for the particular installation?

This section contains the potential errors, resolution steps, and provide users with troubleshooting methods and tips.

The process to check the event list can refers to Manual Chapter 7.3 (B).

Table 8-1 Even list

Even List ID	Event List Name	Even List Description	Solution
ID01	GridOVP	The power grid voltage is too high	If the alarm occurs occasionally, the possible cause is that the electric grid is abnormal occasionally. inverter automatically returns to normal operating status when the electric grid's back to normal. If the alarm occurs frequently,
ID02	GridUVP	The power grid voltage is too low	
ID03	GridOFP	The power grid frequency is too high	

ID04	GridUFP	The power grid frequency is too low	<p>check whether the grid voltage/frequency is within the acceptable range. If no, contact technical support. If yes, check the AC circuit breaker and AC wiring of the inverter.</p> <p>If the grid voltage/frequency is within the acceptable range and AC wiring is correct, while the alarm occurs repeatedly, contact technical support to change the grid over-voltage, under-voltage, over frequency, under-frequency protection points after obtaining approval from the local electrical grid operator.</p>
ID05	GFCIFault	GFCI Fault	<p>If the fault occurs occasionally, the possible cause is that the external circuits are abnormal occasionally. inverter automatically returns to normal operating status after the fault is rectified.If the fault occurs frequently and lasts a long time,check whether the insulation resistance between the PV array and earth(ground) is too low, then check the insulation conditions of PV cable.</p>
ID06	OVRT	OVRT faulty	
ID07	LVRT	LVRT faulty	
ID08	IslandFault	Islanding faulty	
ID09	GridOVPIstant1	Grid instantaneous voltage too high 1	

ID10	GridOVPIstant2	Grid instantaneous voltage too high 2	
ID11	VGridLineFault	Grid Line voltage Faulty	
ID12	InvOVP	Inverter overvoltage	
ID17	HwADFaultIGrid	The grid current sampling error	ID17-ID24 are internal faults of inverter, turn OFF the “DC switch”, wait for 5 minutes, then turn ON the “DC switch”. Check whether the fault is rectified. If no, please contact technical support.
ID18	HwADFaultDCI	The DCI sampling error	
ID19	HwADFaultVGrid (DC)	Grid voltage sampling faulty (DC side)	
ID20	HwADFaultVGrid (AC)	Grid voltage sampling faulty (AC side)	
ID21	GFCIDeviceFault (DC)	Current leakage sampling (DC side)	
ID22	GFCIDeviceFault (AC)	Current leakage sampling (AC side)	
ID23	HwADFaultIdcBranch	Current Branch sampling faulty	
ID24	HwADFaultIdc	DC input current sampling faulty	
ID29	ConsistentFault_GFCI	The GFCI sampling value between the master DSP and salve DSP is not consistent	ID17-ID24 are internal faults of inverter, turn OFF the “DC switch”, wait for 5 minutes, then turn ON the “DC switch”. Check whether the fault is technical support.
ID30	ConsistentFault_Vgrid	The Grid voltage sampling value between the master and salve is not consistent	
ID31	ConsistentFault_DCI		

ID33	SpiCommFault(DC)	SPI Communication Faulty (DC side)	
ID34	SpiCommFault(AC)	SPI Communication Faulty (AC side)	
ID35	SChip_Fault	Chip Faulty (DC side)	
ID36	MChip_Fault	Chip Faulty (AC side)	
ID37	HwAuxPowerFault	Auxiliary power error	
ID38	InverterSoftStartFail	Inverter soft start failed	
ID41	RelayFail	Relay faulty	
ID42	IsoFault	Low isolation faulty	
ID43	PEConnectFault	Ground faulty	
ID44	PvConfigError	Input mode incorrect	
ID45	CTDisconnect	CT error	
ID46	ReversalConnection	Input reverse connection error	
ID47	ParallelFault	ParallelFault	
ID48	SNTypeFault	Serial number error	
ID49	Reserved		
ID50	TempFault_HeatSink1	Heat sink1 over-temperature protection	Ensure the installation position and installation method meet the requirements of Section 4.4 of this user manual.
ID51	TempFault_HeatSink2	Heat sink2 over-temperature protection	Check whether the ambient temperature of the installation position exceeds the upper limit. If yes, improve ventilation to decrease the temperature.
ID52	TempFault_HeatSink3	Heat sink3 over-temperature protection	



ID53	TempFault_HeatSink4	Heat sink4 over-temperature protection	
ID54	TempFault_HeatSink5	Heat sink5 over-temperature protection	
ID55	TempFault_HeatSink6	Heat sink6 over-temperature protection	
ID57	TempFault_Env1	environment temperature 1 protection	
ID58	TempFault_Env2	Ambient temperature 2 protection	
ID59	TempFault_Inv1	Model1 over-temperature protection	
ID60	TempFault_Inv2	Model2 over-temperature protection	
ID61	TempFault_Inv3	Model3 over-temperature protection	
ID65	VbusRmsUnbalance	Unbalanced RMS value of bus voltage	
ID66	VbusInstantUnbalance	Unbalanced instantaneous value of bus voltage	
ID67	BusUVP	Bus undervoltage during grid connection	If the configuration of the PV array is correct, could be the sun irradiation is too low. Once sun irradiation back to normal, inverter will work back normal
ID68	BusZVP	Bus voltage low	
ID69	PVOVP	PV overvoltage	
ID70	Reserved		

ID71	BusOVP	BUS overvoltage	
ID72	SwBusRmsOVP	Inverter bus voltage overvoltage software	
ID73	SwBusInstantOVP	Inverter bus voltage instantaneous value overvoltage software	
ID81	Reserved		
ID82	DciOCP	Dci overcurrent faulty	
ID83	SwOCPIstant	Output instantaneous current protection	ID83 are internal faults of inverter, turn OFF the “DC switch”, wait for 5 minutes, then turn ON the “DC switch”. Check whether the fault is rectified. If no, please contact technical support.
ID84	Reserved		
ID85	SwAcRmsOCP	Output RMS current protection	
ID86	SwPvOCPInstant	PV overcurrent software protection	
ID87	IpvUnbalance	PV flows in uneven parallel	
ID88	IacUnbalance	Output current unbalance	
ID89	SwPvOCP	PV software overcurrent protection	
ID90	IbalanceOCP	Balance electricity passing current protection	
ID97	HwLLCBusOVP	LLC bus hardware overvoltage	

ID98	HwBusOVP	Inverter bus hardware overvoltage	
ID99	HwBuckBoostOCP	BuckBoost hardware overflows	
ID100	Reserved		
ID102	HwPVOCP	PV hardware overcurrent	
ID103	HwACOCP	AC output hardware overcurrent	
ID105	MeterCommFault	Electric meter error	
ID113	OverTempDerating	Overttemperature derating	This faulty only cause alarm, It will not directly cause the system to enter a fault state.
ID114	FreqDerating	Frequency derating	
ID115	FreqLoading	Frequency loading	
ID116	VoltDerating	Voltage derating	
ID117	VoltLoading	Voltage loading	
ID124	Reserved		
ID125	Reserved		
ID129	unrecoverHwAcOCP	Output overcurrent hardware permanent fault	ID129-ID141 are internal faults of inverter, turn OFF the “DC switch”, wait for 5 minutes, then turn ON the “DC switch”. Check whether the fault is rectified. If no, please contact technical support.
ID130	unrecoverBusOVP	Bus overvoltage permanent fault	
ID131	unrecoverHwBusOVP	Bus overvoltage hardware permanent fault	
ID133	Reserved		

ID134	unrecoverAcOCPI nstant	Output transient overcurrent permanent fault	
ID135	unrecoverIacUnba lance	Output current imbalance permanent fault	
ID137	unrecoverPvConfi gError	Input mode setting error permanent failure	
ID138	unrecoverPVOCPI nstant	Input overcurrent permanent fault	
ID139	unrecoverHwPVO CP	Input hardware overcurrent permanent fault	
ID140	unrecoverRelayFa il	Relay permanent fault	
ID141	unrecoverVbusUn balance	Bus Unbalanced permanent fault	
ID142	unrecoverSpdFail( DC)	Lightning protection permanent failure-(DC)	
ID143	unrecoverSpdFail( AC)	Lightning protection permanent failure - (AC)	
ID145	USBFault	USB fault	
ID146	WifiFault	Wifi fault	ID145-ID158are internal faults of inverter, turn OFF the “DC switch”, wait for 5 minutes, then turn ON the “DC switch”. Check whether the fault is rectified. If no, please contact technical support.
ID147	BluetoothFault	Bluetooth fault	
ID148	RTCFault	RTC clock failure	
ID149	CommEEPROMF ault	Communication board EEPROM error	

ID150	FlashFault	Communication board FLASH error	
ID152	SafetyVerFault	SCI communication error (DC)	
ID153	SciCommLose(DC)	SCI communication error (AC)	
ID154	SciCommLose(AC)	SCI communication error (Fuse)	
ID155	SciCommLose(Fuse)	Inconsistent software versions	
ID156	SoftVerError	USB fault	
ID157			
ID158			
ID161	ForceShutdown	ForceShutdown	
ID162	RemoteShutdown	RemoteShutdown	
ID163	Drms0Shutdown	Drms0 shunt down	
ID165	RemoteDerating	RemoteDerating	Inverter shows ID83 when remote derating. If no one operate this function, please check the connection (I/O) according to chapter 4.5
ID166	LogicInterfaceDerating	Logical interface derating	
ID167	AlarmAntiRefluxing	Anti Refluxing derating	
ID169	FanFault1	Fan 1 Alarm	
ID170	FanFault2	Fan 2 Alarm	
ID171	FanFault3	Fan 3 Alarm	
ID172	FanFault4	Fan 4 Alarm	
ID173	FanFault5	Fan 5 Alarm	

ID174	FanFault6	Fan 6 Alarm	
ID175	FanFault7	Fan 7 failure	
ID176	MeterCommLose	Meter communication failure	
ID177	Reserved		
ID178	Reserved		
ID179	Reserved		
ID180	Reserved		
ID181	Reserved		
ID182	Reserved		
ID193- ID224	StringFuse_Fault0 -31	String fuse open circuit alarm	
ID225- ID240	Reserved		

## 8.2. Maintenance

Inverters generally do not need any daily or routine maintenance. But ensure heat sink should not be blocked by dust, dirt or any other items. Before the cleaning, make sure that the DC SWITCH is turned OFF and the circuit breaker between inverter and electrical grid is turned OFF. Wait at least for 5 minutes before the Cleaning.

### ✧ Inverter cleaning

Please clean the inverter with an air blower, a dry & soft cloth or a soft bristle brush. Do NOT clean the inverter with water, corrosive chemicals, detergent, etc.

### ✧ Heat sink cleaning

For the long-term proper operation of inverters, ensure there is enough space around the heat sink for ventilation, check the heat sink for blockage (dust, snow, etc.) and clean them if they exist. Please clean the heat sink with an air blower, a dry & soft cloth or a soft bristle brush. Do NOT clean the heat sink with water, corrosive chemicals, detergent, etc.

# 9. Technical Data

## 9.1. Input parameters (DC)

Parameter	SOFAR 250/255KTL-HV
Max. input voltage	1500V
Rated input voltage	1080V
Start-up voltage	550V
MPPT operating voltage range	500V~1500V
Full power MPPT voltage range	800V~1300V
Number of MPP trackers	12
Number for DC inputs	24
Max. input current per MPPT	30A
Max. input short circuit current per MPPT	50A

## 9.2. Output Parameter (AC)

Parameter	SOFAR 250KTL-HV	SOFAR 255KTL-HV
Rated output power	250kW	253kW
Maximum apparent power	250kVA@30°C / 235kVA@40°C / 220kVA@50°C	255kVA@30°C / 235kVA@40°C / 220kVA@50°C
Rated output current	162A	166A
Max. Output current	180.5A	184A
Nominal grid voltage	3W+PE, 800Vac	
Grid voltage range	640~920Vac	
Nominal frequency	50Hz / 60Hz	
Grid frequency range	45~55Hz / 55~ 65Hz	
Active power adjustable range	0~100%	
THDi	<3%	
Power factor	1 default (-0.8...+0.8 adjustable)	



### 9.3. Performance Parameter

Parameter	SOFAR 250KTL-HV	SOFAR 255KTL-HV
Max efficiency	99.01%	
European Weighted efficiency	98.8%	
MPPT efficiency	>99.9%	
EMC	EN 61000-6-2, EN 61000-6-4	
Safety standard	IEC62109-1/2, IEC62116, IEC61727, IEC-61683, IEC60068(1,2,14,30)	
Grid standard	AS/NZS 4777, VDE V 0124-100, V 0126-1-1, VDE-AR-N 4105, CEI 0-21/CEI 0-16, UNE 206 007-1, EN50549, G99, EN50530, NB/T32004	
Protection	Leakage current/Anti-islanding /DC reverse polarity/ZVRT/AC and DC secondary lightning protection	
Ground fault monitoring	Yes	
PV-array string fault monitoring	Yes	
Zero voltage ride through	Yes	
Anti-PID function	Optional	
AFCI protection	Optional	
Protection class/ overvoltage category	I/III	
Input/ output SPD	PV: type II standard AC: type II Standard	

## 9.4. General Data

Parameter	SOFAR 250KTL-HV	SOFAR 255KTL-HV
Topology	Transformless	
Ambient temperature range	-30°C~+60°C	
Relative humidity	0%~100%	
DC Switch	Yes	
Cooling	Smart forced air cooling	
Max.altitude	5000m(> 4000m derating)	
Mounting	Wall mount	
Communication	WiFi /GPRS /RS485/PLC/Bluetooth (optional)	
Display	LCD& Bluetooth +APP	
Self-consumption at night	<2W	
Degree of protection	IP66	
Dimension	1100.5×713.5×368mm	
Weight	99.3kg	
Warranty	5 years/ 7 years/ 10 years	

# 10. Quality Assurance

## Standard warranty period

The standard warranty period of inverter is 60 months (5 years). There are two calculation methods for the warranty period:

Purchase invoice provided by the customer: the first flight provides a standard warranty period of 60 months (5 years) from the invoice date;

The customer fails to provide the invoice: from the production date (according to the SN number of the machine), Our company provides a warranty period of 63 months (5.25 years).

In case of any special warranty agreement, the purchase agreement shall prevail.

## Extended warranty period

Within 12 months of the purchase of the inverter (based on the purchase invoice) or within 24 months of the production of the inverter (SN number of machine, based on the first date of arrival), Customers can apply to buy extended warranty products from the company's sales team by providing the product serial number, Our company may refuse to do not conform to the time limit extended warranty purchase application. Customers can buy an extended warranty of 5, 10, 15 years.

If the customer wants to apply for the extended warranty service, please contact the sales team of our company. to purchase the products that are beyond the purchase period of extended warranty but have not yet passed the standard quality warranty period. Customers shall bear different extended premium.

During the extended warranty period, PV components GPRS, WIFI and lightning protection devices are not included in the extended warranty period. If they fail during the extended warranty period, customers need to purchase and replace them from the our company.

Once the extended warranty service is purchased, our company will issue the extended warranty card to the customer to confirm the extended warranty period.

### **Invalid warranty clause**

Equipment failure caused by the following reasons is not covered by the warranty:

- 1) The "warranty card" has not been sent to the distributor or our company;
- 2) Without the consent of our company to change equipment or replace parts;
- 3) Use unqualified materials to support our company 's products, resulting in product failure;
- 4) Technicians of non-company modify or attempt to repair and erase the product serial number or silk screen;
- 5) Incorrect installation, debugging and use methods;
- 6) Failure to comply with safety regulations (certification standards, etc.);
- 7) Damage caused by improper storage by dealers or end users;
- 8) Transportation damage (including scratches caused by internal packaging during transportation).Please claim directly from the transportation company or insurance company as soon as possible and obtain damage identification such as container/package unloading;
- 9) Failure to follow the product user manual, installation manual and maintenance guidelines;
- 10) Improper use or misuse of the device;
- 11) Poor ventilation of the device;
- 12) The product maintenance process does not follow relevant standards;
- 13) Failure or damage caused by natural disasters or other force (such as earthquake, lightning strike, fire, etc.)



Product Name: PV Grid-Connected Inverter

Company Name: Shenzhen SOFARSOLAR Co., Ltd.

ADD: 401, Building 4, AnTongDa Industrial Park, District 68, XingDong Community,  
XinAn Street, BaoAn District, Shenzhen, Guangdong.P.R. China

Email: [service@sofarsolar.com](mailto:service@sofarsolar.com)

Tel: 0510-6690 2300

Web: [www.sofarsolar.com](http://www.sofarsolar.com)